

47
March
1987



142

elektor

INDIA

Rs. 7.50

electronics

VLF ADD-ON UNIT FOR OSCILLOSCOPES

Handwritten signature in blue ink, possibly 'Suresh Singh', written vertically on the left side of the oscilloscope.

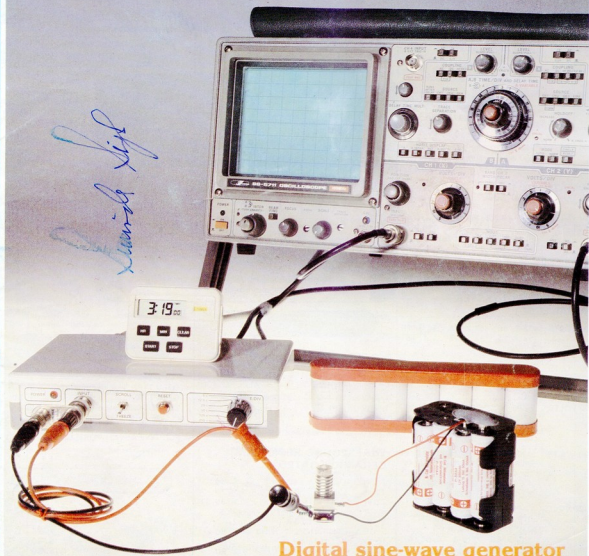

**Digital sine-wave generator
In-car ioniser**

Publisher: C.R. Chandarana

Editor: Surendra Iyer
Editorial Assistance: Ashok Dongre
General Manager: J. Dhas
Advertising: B.M. Mehta
Production: C.N. Mithagari

Address:

ELEKTOR ELECTRONICS PVT. LTD.
52, C Proctor Road
Bombay - 400 007 INDIA
Telex: (011) 76661 ELEK IN

Overseas editions:

Elektor Electronics
Standfast House
Bath Place
High Street, Barnet
Herts EN5 5XE U.K.
Editor: Ian Seymour

Publitrón Publicações Técnicas Ltda
Av Ipiranga 1100, 9º andar
CEP 01040 São Paulo — Brazil
Editor: Juliano Barsali

Elektor srl
Route Nationale: Le Saut; B.P. 53
59270 Bailleul — France
Editors: D R S Meyer;
G C P Raedersdorf

Elektor Verlag GmbH
Susterfeld-Straße 25
100 Aachen — West Germany
Editor: E J A Krempelsauer
Elektor EPE
Karaiskaki 14
16673 Voula — Athens — Greece
Editor: E Xanthoulis

Elektuur B.V.
Peter Treckpoelstraat 2-4
6191 VK Beek — the Netherlands
Editor: P E L Kersemakers
Ferreira & Bento Lda.
R.D. Estefânia, 32-1º
1000 Lisboa — Portugal
Editor: Jorge Goncalves
Ingelek S.A.
Av. Alfonso XIII, 141
Madrid 16 — Spain
Editor: A M Ferrer

In part:

Kedhorn Holdings PTY Ltd
Cnr Fox Vajley Road &
Kiggle Street
Wahroonga NSW 2076 — Australia
Editor: Roger Harrison
Electronic Press AB
Box 63
182 11 Danderyd — Sweden
Editor: Bill Cedrum

The Circuits are for domestic use only.
The submission of designs of articles of
Elektor India implies permission to the
publishers to alter and translate the text
and designed to use the contents in
other Elektor publications and activities.
The publishers cannot guarantee to
return any material submitted to them.
All drawings, photographs, printed
circuit boards and articles published in
Elektor India are copyright and may not
be reproduced or imitated in whole or
part without prior written permission of
the publishers.

Patent protection may exist in respect of
circuits, devices, components etc.
described in this magazine.

The publishers do not accept
responsibility for failing to identify such
patent or other protection.

Printed At:
Trupti Offset
Bombay - 400 013
Ph. 4923261, 4921354



Copyright © 1987 Elektor B.V.
The Netherlands



Volume-5 Number-3
March-1987

Electronics Technology

Its master's voice	3.19
The razor edge of the excimer laser	3.25
Field-effect optocoupler	3.37

Projects

Digital sine-wave generator	3.21
VLF add-on unit for oscilloscopes	3.27
ROM/RAM card for Electron plus One	3.32
Software for the BBC computer-3	3.35
Micro-squeaker	3.36
Battery saver	3.39
MSX extensions - 4	3.40
The Junior Computer as a frequency counter	3.45
In car ioniser	3.47

Information

News ● News ● News ●	3.16
Junior Computer facts	3.45
New products	3.58
Infosheet	3.67
Licences & letters of intent	3.70

Guide lines

Switch board	3.63
Classified ads	3.74
Index of advertisers	3.74
Corrections	3.74

Selex-21

Charging/Discharging	3.50
Phase-shift	3.52
Simple dimmer	3.54
Half wattage dimmer	3.56

Introducing THE MEMBRANE KEYBOARD

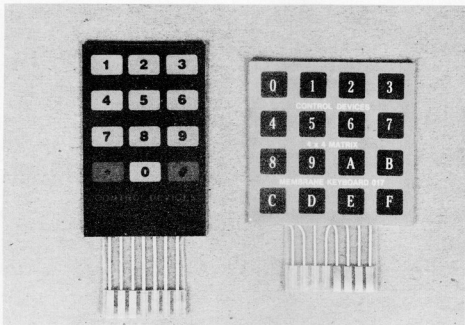

CONSTRUCTION OF OUR MEMBRANE KEYBOARDS

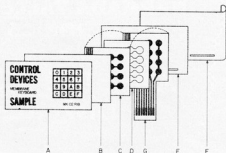

- A: **Multi colour graphic panel** — Can be made to any size and printed in multicolour designs as required. It is possible to illuminate keys from behind to enhance the graphics. A tactile snap action feedback can be achieved by embossing on the panel.
- B: **Supporting adhesive sheet** — Mounts the panel and fixes it firmly.
- C: **Circuit layers** — High grade heat stabilized polyester film used for a long life. As Conductive Silver Ink is used, there is very low contact resistance, which is better than graphite or copper used in most switches.
- D: **Spacer** — Since a thin spacer is used, little actuation force is required reducing operator fatigue.
- E: **Backing sheet** — Gives a stable substrate to the keyboard, and offers mounting ease. Super strong pressure sensitive adhesive gives a long life and never failures.
- F: **Release paper** — Just unpeel and stick the keyboard on the surface of the device. This saves a lot of assembly time.
- G: **Flex lead** — Used to connect the keyboard to the circuit. Can be of any length or dimensions required for various connection layouts.

Membrane Keyboards offer

higher reliability,
more durability,
greater customer appeal,
and lower cost.

Now available indigenously in
Rigid and Flexible types
with or without tactile
feedback to custom designs

Contact us for further information at:

CONTROL DEVICES
243 Madhani Estate,
Senapati Bapat Marg,
Dadar (West),
Bombay - 400 028
India
Tel: (022) 422 2636
422 1682

AVAILABLE EX STOCK

- COMPUTER PERIPHERALS & MEDIA PRODUCTS
- RANGE OF GODREJ PRINTERS & EPSON DOT MATRIX PRINTERS
- PHILIPS FLOPPY DRIVES
- RANGE OF SMPS
- CONNECTORS
- KEY BOARDS FOR PC-XT & AT
- SET OF CARDS FOR PC/XT & AT
- MONITORS-MONOCROME & COLOUR
- RANGE OF PRINTER RIBBONS
- RANGE OF FLOPPY DISKETTES (IMPORTED)
- CABINETS FOR PC/XT & AT

**GENERAL ELECTRONIC ITEMS
ARE ALSO AVAILABLE WITH US**

**MAINTENANCE/REPAIRS OF
SMPS/DPM/DMM UNDERTAKEN**

ABC ELECTRONICS

339/65 RAJESH BUILDING, 1ST FLOOR, OPP. POLICE STATION LAMINGTON ROAD,
BOMBAY - 400 007 Ph. 38 61 78 Telex - 011-76393 GENE IN

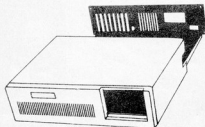
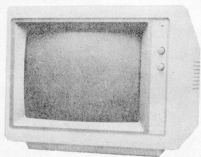
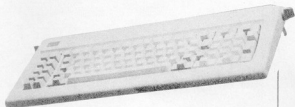
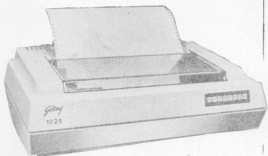

Quality & Creativity From:

LUXCO®

Range of 'TV' speakers

COLOR T.V. SPEAKERS			
TYPE/DIMENSION	M.M./INCHES	WATT	COMPATIBLE
8x13 LCT 3/5	78x118 (3 1/4"x4 1/4")	3W/5W	CONTEC/TOSHIBA
10x15LCT6-D	104x150 (4"x6")	6W	GRUNDIG/PHILLIPS
10 LCT 3	104x104 (4"x4")	3W	SONY/SHARP/LVC.
10 LCT 5	104x104 (4"x4")	5W	-Do-
9 LCT 3	90 (3 1/2")	3W	CONTEC/J.V.C.
9x5.5 LWCT2	90x55 (3 1/2"x2.6")	2W	TOSHIBA/CORE
B/W T.V. SPEAKERS			
8 LG 1/2	77 (3")	1W/2W	DAEWOO (14")
9 LG 2/3	90 (3 1/2")	2/3W	DO/CONTEC. (14")
10 LG 3/5	104 (4")	3/5W	SONY/GOLDSTAR (20")
7x10 LG 2	65x103 (2 1/2"x4")	2W	(14")
8x13 LG 3/5	78x118 (3 1/4"x4 1/4")	3/5W	CONTEC/SOMPU (20")
10x15 LG 6	104x150 (4"x6")	6 W	PHILLIPS/NEL. (20")
TWEETER			
5 LT 5 *	50 (2")	5W	FOR COLOR T.V.
5 LT 10**	50 (2")	10 W	FOR B/W T.V.
3 LT 10**	25 (1")	10 W	FOR COLOR T.V.
2 LTD 15	20 (3/4")	15 W	"
1LDT 10	10 (1/2")	10 W	"

Tweeters And Flat Cone Woofers

- Manufactured by:
LUXCO Electronics
Allahabad-211 003
- Sole Selling Agents:
LUXMI & CO.
56, Jahnstonganj
Allahabad-211 003
Phone: 54041, Telex: 540-286
- Distributors for Delhi & Haryana:
Railton Electronics
Radio Place, ChandniChowk
Delhi-110 006
Phone: 239944, 233187

- Distributors for Maharashtra,
Gujarat and South India:

precious®
Electronics Corporation

- Chofani Building, 52, Proctor Road,
Grant Road (East), Bombay-400 001
Phones: 367459, 369478
- 9, Athipattan, Street, Mount Road,
Madras-600 002, Phone: 842718.

sound technology from a sound source

LOST on the Data Highway?

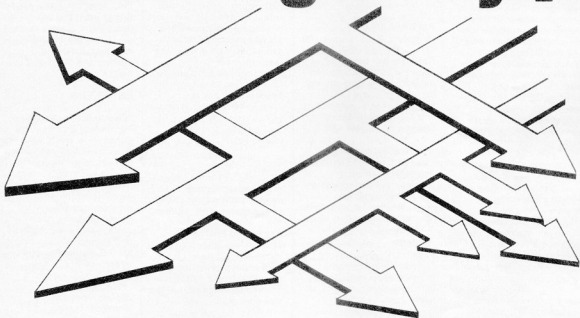

Are you getting perplexed by the advances in microprocessor and computer technology? Confused by the jargon of process control experts?

There is no reason to get disappointed. You can still catch up with them, and fast! With Dynalog on your side, nothing is impossible. Dynalog offers the widest range of Microprocessor Training and Development Systems, based on all popular Microprocessors like 8085, Z80, 6802, 6502, 8086, 8088 and 68000. The range also includes one 8085 based system specially designed for learning Process Control Applications. Various building block type STD Bus compatible cards for OEM applications are also available from Dynalog.



Dynalog Micro-Systems

14, Hanuman Terrace, Tara Temple Lane,
Lamington Road, Bombay 400 007

Tel: 362421, 353029 Telex: 011-71801 DYNA IN Gram: ELMADEVICE

ADDMark

Its master's voice



Dragon dictates

It is quicker to read a book than have it read to you. But it is quicker to make a speech than to write it. In an ideal world, therefore, busy businessmen would receive information on paper and impart it in speech. But they do not, because the spoken and written word remain separate. The door between them is guarded by the formidable power of the typing pool.

Not many years from now, those typists will have been replaced by machines. There are already devices on the market that factory managers can use to record stocks or orders, or that car-telephonists can use to dial numbers by voice.

Kurzweil Applied Intelligence, a small company based in Waltham, Massachusetts, and founded by Dr Ray Kurzweil, has taken this idea a stage further and has sold 400 of what it calls "voice systems". A voice system can learn how an individual speaks 1,000 words and then turn any word it hears into the same set of signals as a keyboard would deliver to a personal computer.

So, for example, Dr Alan Robbins, a radiologist at the New England Baptist Hospital, has given a voice system the basic vocabulary of X-rays, so that he can dictate to it while describing the results of an X-ray. Doctors would benefit greatly from dictation machines: most of their communication is in the form of hand-written notes to each other; one study found that 16% of the words in such notes were illegible.

To build a dictation machine that can distinguish between the thousands of words that people use in writing to each other, and yet not confuse any two of them, is much harder. Dr John Makhoul of Bolt Beranek

and Newman (BBN), which has a contract from the American Defence Department to develop speech-recognition technology, compares it with trying to read handwriting in which not only are all words connected, but the shape of each letter depends on the letters that precede and follow it. People do not leave gaps between words in speech as they do on paper: in the chart below, note that the gaps correspond to consonants, not word endings.

None the less, thanks to the arrival of customized chips and dirt-cheap computing power, it is now possible to build a device that can hear each of thousands of words correctly and within half a second in more than 95% of cases. Venture capitalists have got wind of this. Companies are springing up throughout the high-tech belts of America to build "computer ears". For now, do not believe their claims: a good audio typist can beat the pants off any machine yet devised. But had ones will soon feel the cold breath of mechanical competition.

At least three companies are close to market. Kurzweil was probably the first. Its 10,000-word voice writer will sell for under \$10,000 when it is eventually launched (sometime in the first half of this year is the latest of several guesses). It will come with a basic vocabulary of 6,500 words that will need a few hours' training to each user's voice and will be able to add new words that you teach it up to a total of 10,000 or so. Kurzweil has invented its own chip, the KCS2408, for the voice writer, which will be a box that goes between the microphone and an IBM-PC-AT personal computer.

Dragon Systems, a small company based in Newton, Massachusetts, is taking a different approach. Its main concern is to get the cost right down so that \$50 voice engines with 50 cent microphones can be fitted to any desktop microcomputer. In 1983, its founders, Dr Jim and Dr Janet Baker, licensed their technology for \$10 a unit to Apricot, a British computer maker,

which produced the first computer with an elementary built-in ear.

Cherry Electrical, a Chicago keyboard maker, has bought licences for \$200 a unit for Dragon's 1,000-word recognisers, which it sells for \$1,200. Dragon's advantage is that it does not rely on any special chips: all its speech-recognition programs can run on general-purpose microprocessors. Once microcomputers based on the new generation of Intel 80386 chips become available, Dragon hopes to have 10,000-word recognising technology available.

For once, IBM is among the leaders of the race, thanks to a talented team under Dr Fred Jelinek at the company's Thomas Watson Research Centre at Yorktown Heights in New York State. In 1984, it demonstrated a 5,000-word device that required a mainframe computer and three array processors. In April last year, it did the same on a personal computer, by using two chips called digital signal processors developed at IBM's laboratories in Switzerland and France.

Dr Jelinek now says he has gone even further and given a PC a vocabulary of 20,000 words. IBM calls the speech recogniser Tangora, after Albert Tangora, the world's fastest typist. It has not yet said when it will be selling Tangoras. Dr Jelinek plans to distribute a few dozen to offices in IBM research laboratories next year for evaluation.

Setting limits

Kurzweil, Dragon and IBM all realise that the only way to tackle speech recognition is to limit the problem in four ways:

- **Vocabulary.** A large vocabulary can be made manageable by teaching a machine elementary grammar. For example, sentences are more likely to begin with "man" than "than". Dr Susumu Kuno, a Harvard professor, whose skills of syntax are incorporated into Kurzweil's voice writer, divides speech into about 400 kinds of words and defines which kinds of words follow which in an English sentence. IBM uses



Kurzweil abandons the keyboard

what it calls a "trigram" approach: given the two preceding words, it predicts the third.

Most researchers reckon a good dictation machine would have to know 20,000 words. Kurzweil disagrees. The vocabulary of even an educated English speaker is surprisingly small. Shakespeare used about 30,000 words in all his writing, but most people are much less prolific. Mr Robin Kinkead, director of design at Kurzweil, found that he had used 8,000 different words in all his writing during two years (113,000 words in total) and only 4,000 of those were used more than once. IBM has searched 27m words of office correspondence to glean the 20,000 words most commonly employed for its Tangora. Those 20,000 account for 98% of the total.

- **Connected speech.** All three machines require each word to be spoken in isolation from its neighbours. This greatly facilitates recognition, but it is inconvenient, slow and is plainly not how the human mind works. However, even with gaps between words, it should be possible to dictate to Kurzweil's voice writer at a rate of about 60 words a minute—considerably faster than most professionals type, though well short of Mr Tangora's 147 words a minute.

Isolated speech may turn out to be a technological dead-end. Dr Kurzweil does not think so. He says his voice writer will be able to handle connected speech by 1988. IBM's Dr Jelinek reckons it will require a tenfold increase in computing power. But BBN's Dr Makhoul says that you cannot tackle connected speech without sacrificing performance on other counts.

• **Speaker dependence.** To be good, speech recognisers will have to be trained to an individual's voice. Where the ability to recognise any voice is required (eg. dialling telephone numbers), either vocabulary will have to be limited or errors tolerated.

Training the machine to your voice will be tedious: once the vocabulary gets much above 1,000 words, it is impractical to sit down and repeat each word three times. Kurzweil's solution is to get a sample of up to 2,000 words from the speaker and use those to infer how he will speak other words. Then, when it hears him say the real word, it substitutes the real thing for its guess. IBM's Tangora is trained by the user reading a set text of 1,100 words, from which it "accents" its representations of the other words in its vocabulary.

• **Background noise.** Given a high-fidelity microphone and no noise in the background, a computer will make a better job of recognising each word than over a noisy, long-distance telephone line with its narrow range of frequencies and crackles. Again, each designer has to choose whether to sacrifice performance for robustness, or vice versa.

Look, no hands

Nobody knows quite what the implications of computers taking dictation will be. One of Kurzweil's best ideas has been to send Mr Kinkead to find out what people want from such a

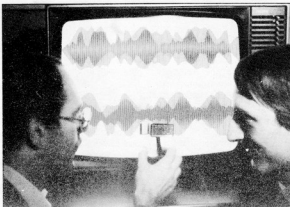

Eavesdropping on Jelinek

machine and design it accordingly. Mr Kinkead's main discovery was that people do not want to see a keyboard at all. They want not only to dictate their computer, but to correct words, move around the screen and sign off with spoken commands. If they have not learnt to type before, they do not want to start now.

So, although the Kurzweil voice writer will work with any word-processing program, it can be entirely controlled by speech. "Listen-to-me" wakes the computer up; "move-right" moves the cursor right; "next-choice" corrects a wrongly heard word by telling the computer to substitute its second-best guess. Connected words are used in such commands and isolated ones in dictation. Kurzweil reckons that the market for the voice writer will be lawyers, doctors and middle managers, who generate a lot of

text. And many disabled people should benefit. Stanford University and America's Veterans Administration are developing a robot with wheels and a mechanical arm that is controlled by a voice system.

Speakers of Japanese and Chinese have even more reason to welcome speech recognisers than English speakers, as they struggle to design keyboards that can manage many thousands of characters. NEC already makes a 500-word recogniser and Fujitsu a 256-word one.

Such machines need not confine their recognition to words. Kurzweil discovered that one of the customers who bought its voice system was using it to identify the sound of faulty bearings in machinery. In a playful mood, some of Kurzweil's scientist taught the machine to distinguish three different kinds of bark by one of

their dogs, as "animal in the yard", "somebody at the door" and "let me out". It worked well.

The machines described in this article mark only the beginning. By the end of the century, they will be as obsolete as typewriters. Some of the speech-recognition projects—especially those paid for by defence departments to help fighter pilots do a dozen things at once in dogfights—give a glimpse of what will one day be achieved.

Bolt Beranek and Newman, using enormous computing power (a Symbolics Lisp machine or one of BBN's own parallel computers, called Butterflies), is in no hurry to get a product to market. It eschews isolated words and works instead with connected speech. It is still restricted to a small vocabulary and it takes minutes for a long sentence, but it works. To watch it gradually making up its mind about what you said (and puzzling over your English accent) is eerie.

An even more futuristic idea is exciting Mr John Bridle and Dr Roger Moore at one of Britain's defence-research laboratories, the Royal Signals and Radar Establishment in Malvern, Worcestershire. They want to try speech recognition on a new generation of computers called either "Boltzmann machines" or perceptrons. These are networks of microprocessors built to imitate primitive brains.

Anatomy of a computer's ear

In the 1960s, most researchers assumed that speech recognition was simply a matter of distinguishing the "shape" of each "phoneme" (syllable or consonant group) and translating that into words. But that approach has proved unrewarding, because it underestimates the variability and ambiguity of speech. Compare "this new display can recognise speech" with "this nudist play can wreck a nice beach".

Today a different mood prevails. IBM's Dr Jelinek jokes that his system improves every time he gets rid of an "expert". What he means is that, given lots of data, computers are better at deducing what to measure so as to distinguish words than humans are. At its simplest, this means measuring the statistical similarity between a stored template (of a word usually) and the sound that has been heard. But it is never as easy as that. For a start, words vary in length according to the speed at which they are spoken and according to their context. They have to be "time-warped" to a standard length. But it does not help to time-warp them by a set amount. Say the word "three" slowly and it is the *ee* that gets lengthened, not the *thr*. The answer is dynamic time-warping, a mathematical trick that matches two spectrograms of uneven length.

But if you try hard enough, you can dynamically time-warp one word into almost any other. The time-warping has to be constrained. The cleverest way of doing this leads to a whole new approach to speech recognition. Called "hidden Markov modelling" after a Russian mathematician who analysed "Eugene Onegin", it was first applied to speech recognition by Dr Jim Baker, now the chief executive officer of Dragon. It gets away from the idea of comparing word templates, comparing instead tiny fragments of speech with stored patterns, and, in particular, the probability that one fragment will be preceded and followed by another. It is "hidden", because the answer it gives for each sound is itself statistical and based on the computer's own ability to learn from examples.

The statistical approach stumbles over short words, not long ones, which include more distinctive features. "Disestablishmentarianism" is easier than "it", "if", "is" and "in". This is where the linguistic rules come in. "In America" is a more likely phrase than "it America". But "if America" and "is America" are both plausible. No single approach, acoustic or linguistic, is as good as their combined efforts. What Kurzweil's scientists have done is to use seven pieces of software (which they call "experts") to attack each word and then vote on the answer.

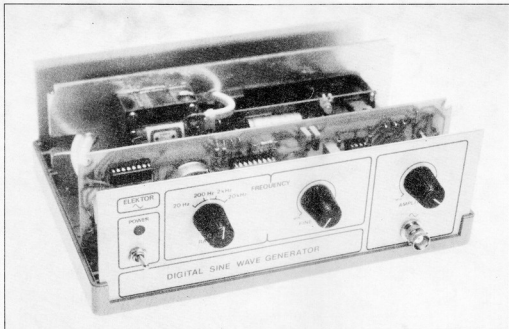

DIGITAL SINE-WAVE GENERATOR

This simple to build AF generator can output a digitally obtained sinusoidal output signal in the 2 Hz to 20 kHz range.

There are various ways of generating a sine-wave signal in the AF range, and numerous designs to this effect have already been published in this magazine. However where the main concerns of the user include a high degree of output level stability, low distortion and reliable coverage of the full AF spectrum, quite a number of basic designs fall short of the necessary performance in these and other important respects.

The generator described in this

article outputs a sinusoidal waveform obtained from an EPROM, i.e. a digital storage medium. The data stored in the EPROM (Erasable Programmable Read Only Memory) is the template, so to speak, for the output waveform. As shown in Fig. 1, a clock generator, three dividers, and a cyclic address counter cause the data bytes in the EPROM to be fed to a digital-to-analogue converter (DAC), whose output signal is cleaned with the aid of a tracking low pass filter. An output

amplifier has been included to ensure a sufficiently low generator output impedance.

Circuit description

With reference to the circuit diagram, Fig. 2, the tunable clock oscillator is composed of monostable multivibrators MMV₁ and MMV₂. Frequency range switch S_{1a} selects the appropriate output from divider chain IC₂-IC₃, while P_{1a} is used as the fine adjustment for the generator output frequency.

The oscillator circuit with the two MMVs ensures a stable output clock signal over the entire 128 kHz to 1.28 MHz range. The oscillator and the divider chain can supply the following frequency ranges:

128 Hz...1.280 Hz (IC_{3a}; S_{1a}-1),
1280 Hz...12.8 kHz (IC_{2a}; S_{1a}-2),
12.8 kHz...128 kHz (IC_{2a}; S_{1a}-3)
and 128 kHz...1.28 MHz (MMV₁/
MMV₂; S_{1a}-4). As each period of the output sine-wave is generated in 64 steps, the generator has an output frequency range of 2 Hz to 20 kHz.

The clock pulses at the pole of S_{1a} are inverted with the aid of MOSFET T₁ to ensure the correct phase relation between FF₁ and IC₃, a Type 4040 binary counter, which drives the address input lines A₀...A₅ of the EPROM containing the digital pattern for one period of the sine-wave. It is seen that only 64 from the 8192 bytes available in the Type 2764 EPROM are used (6 address lines, A₀...A₅; 2⁶=64). This is, admittedly, rather a waste of memory capacity, but it must not be forgot-

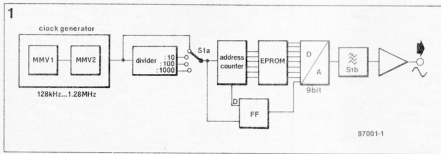

Fig. 1 Block diagram of the digital sine-wave generator. The cut-off frequency of the low-pass output filter is switched along with the frequency range setting.

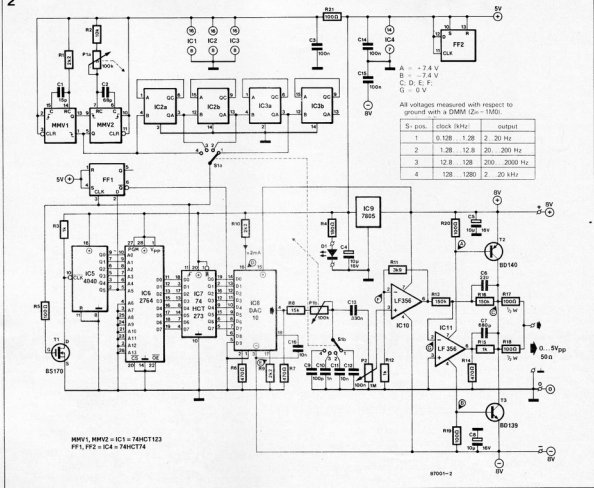

Fig. 2 Circuit diagram of the digital sine-wave generator. The output waveform is stored in an EPROM.

ten that, in general, EPROMs in the 27XXX series offer shorter access times as their holding capacity increases. The Type 2764 is now widely available, and its price has come down to the level of a 450 ns type 2732. The majority of manufacturers of the 2764 specify a device access time of the order of 250 ns, being the maximum permissible value for the EPROM used in this circuit.

Output Q_5 of cyclic counter IC₅ goes high after every 32nd pulse transition at the CLK input. This event causes bistable FF₁ to toggle and drive data input D_0 of DAC IC₉ low. Latch IC₇ is inserted between the data outputs of the EPROM and the data inputs of the DAC to ensure that glitch-free logic levels are transferred during the rising edge of a clock pulse.

As counter IC₅ addresses all 64 memory locations in the EPROM, each of the succes-

sive output bytes represents an instantaneous voltage of the output sine-wave. Table 1 shows the contents of the EPROM. Assuming that IC₅ has not yet reached output state 32, its Q_5 output is low, and the \bar{Q} output of FF₁ drives DAC databit D_0 high. Therefore, the first 32 hexadecimal values to be converted by the DAC are 100, 119, 132, ... 119. Then, FF₁ toggles, and D_0 of the DAC is driven low, causing the next 32 steps to be 0FF, 0E7, ... 0CE, 0E7. Thus, the positive half period of the sine-wave is written with counter states 0 .. 32 ($D_0 = 1$), the negative half period with counter states 33 .. 64 ($D_0 = 0$). With 64 memory locations, 9-bit conversion values are available for the DAC in phase increments of 5.625° ($360^\circ/64$). The attainable resolution for the steps is $U_0/2^9$.

The staircase-like output signal of the DAC is fed to a variable-R.

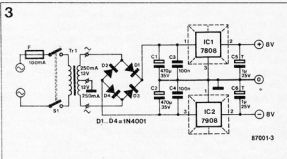

Fig. 3 Suggestion for a simple power supply. Note that a 5 V regulator is fitted on the generator board.

000	00	19	32	4A	62	78	8A	A2
008	04	05	04	E1	EC	F4	8A	FE
010	FF	FE	FA	F4	EC	E1	D4	C5
018	B4	A2	8E	78	62	4A	32	19
020	FF	E7	CE	B6	9E	88	72	5E
028	4C	3B	2C	1F	14	0C	06	02
030	01	02	06	0C	14	1F	2C	3B
038	4C	5E	72	88	9E	B6	CE	E7

Table 1. Hexadecimal representation of the contents of EPROM IC₁₂.

Parts list

(generator board; Fig. 4)

Resistors ($\pm 5\%$)R₁; R₂; R₃ = 2K2R₄ = 10KR₅; R₇; R₁₃ = 1K0R₆ = 180RR₈; R₉; R₂₂; R₂₃ = 100RR₁₀; R₁₄ = 470RR₉ = 15KR₁₁ = 3K9R₁₂; R₁₆ = 150KR₁₇; R₁₈ = 100R; 0.5 WP₁ = 100K stereo potentiometer;
linearP₂ = 1M0 potentiometer; linear

Capacitors:

C₁ = 15p ceramicC₂ = 68p ceramicC₃; C₇; C₁₄; C₁₅ = 100nC₄; C₅; C₆ = 10 μ ; 16 V electrolyticC₈ = 22p ceramicC₇ = 680p ceramicC₉ = 100p ceramicC₁₀ = 1nC₁₁; C₁₆ = 10nC₁₃ = 330n

Semiconductors:

D₁ = LEDT₁ = BS170T₂ = BD140T₃ = BD139IC₁ = 74HCT123IC₂; IC₃ = 74HCT390IC₄ = 74HCT74IC₅ = 74HCT4040IC₆ = 2764 EPROM (t_{acc} \leq 250 ns)IC₇ = 74HCT273IC₈ = DAC10 (Raytheon, PMI);
suffix FX or GX*IC₉ = 7805IC₁₀; IC₁₁ = LF356

26777; or from RR Electronics •

Telephone: (0234) 47188.

Miscellaneous:

S₁ = 2-pole, 4-way rotary switch
for panel mounting.

Power supply as shown in Fig. 3.

PCB Type 87001.*

Recommended enclosure: Verobox

type 075-01411D.

Single-hole BNC socket.

Front panel foil Type 87001 F*.

Soldering pins as required.

* Available from STC Electronic
Services • Telephone: (0279)* Available through our Readers
Services.

4

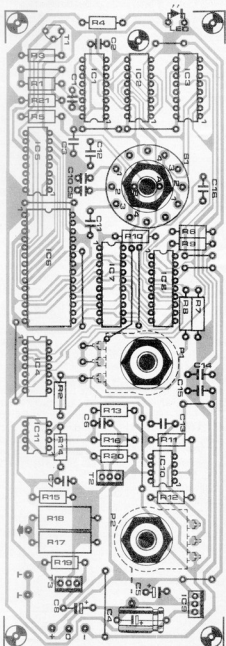
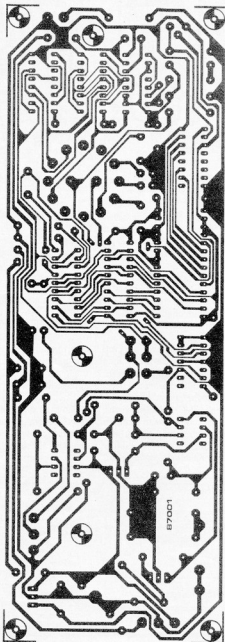

Fig. 4 Track layout and component mounting plan for the sine-wave generator.

fixed-C low-pass filter, whose cut-off frequency is arranged to track along with the generator output frequency. The filter is required to smooth the staircase into a sine-wave, and at the same time to suppress harmonics and spurious DAC output signals. The simple R-C filter offers a skirt steepness of about 6 dB/octave, which is adequate, as the first strong spurious signal has a frequency 64 times that of the fundamental note. The output amplifier of the sine-wave generator is based around IC₁₀, IC₁₁, T₂ and T₃. The latter two are medium-power transistors in a balanced power output stage capable of driving relatively low-impedance loads ($Z_{out} \approx 50 \Omega$). The output amplitude of the generator can be adjusted with P₂.

The generator board comprises its own 5 V regulator. Therefore, a simple, symmetrical 8 V supply suffices to feed the instrument—Fig. 3 shows a standard design to accomplish this. LED D₁ on the generator board is used as the power on/off indicator.

Construction

The sine-wave generator is constructed on ready-made PCB Type 8700L. With Fig. 4 and the parts list to hand, no constructional problems are envisaged. The frequency and amplitude controls are fitted straight onto the board to enable this to be mounted vertically, behind the enclosure front panel. Make sure that you use good quality presets in the P₁ and P₂ positions, else the stability of the generator output signal will be affected. Power semiconductors T₂, T₃ and IC₅ can do without heatsinks, but due account should be taken of the potential at their metal mounting tabs. The spindles of S₁, P₁ and P₂ are left long enough to protrude through the instrument's front panel. The output of the generator is made with a single-hole type BNC socket.

As to the power supply, this is constructed on PCB Type 9968—see Fig. 5. The regulators are best fitted onto a metal surface, e.g. on an aluminium plate cut to slide into the slots at the rear of the Verobox enclosure. Do not forget to fit both the 7810 and the 7910 with insulating washers to preclude short circuits via the cooling surface.

Parts list (supply board; Fig. 5)

Capacitors:

C₁, C₂ = 470 μ ; 35 V axial electrolytic
C₃, C₄ = 100n
C₅, C₆ = 1 μ ; 25 V tantalum

Semiconductors:

D₁... D₄ incl. = 1N4001
IC₁ = 7808
IC₂ = 7908

Miscellaneous:

F = 100 mA delayed action fuse.
Tr₁ = 2 \times 12 V, 250 mA.
S₁ = double-pole mains switch.
Insulating washers and bushes for IC₁ & IC₂.
Mains entrance socket.
Fuseholder for F.
Soldering pins as required.
PCB Type 9968 5 (see Readers Services).

The fitting of the mains input socket, the fuseholder, and the mains transformer, Tr₁, is fairly straightforward, requiring no further detailing. Observe the rating of S₁ to make sure that it can be used as a mains switch, and be careful to keep the two mains wires running to the front panel well away from the generator board. Play it safe!

Setting up and filter considerations

To begin with, the ± 8 V supply is separately tested by measuring its open-circuit output voltage. Connect the completed generator board, switch on, and see if the LED lights. The precise adjustment of the D-A converter can be carried out by temporarily replacing R₁₀ with a 5K0 multiturm preset, and connecting a digital ammeter between pin 16 of IC₆ and the preset. Make sure that the preset has previously been set

5

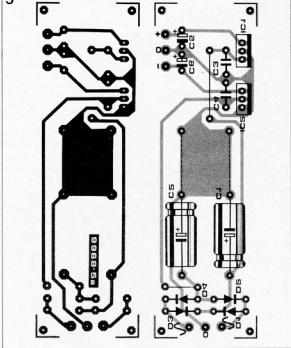

Fig. 5 Track layout and component mounting plan for the 8 V symmetrical power supply.

to about the centre of its travel, and adjust it for a current of 2.000 mA. Remove it, measure its resistance, and fit an appropriate high-stability resistor in the R₁₀ position. While you have the board lying in front of you to perform this test, it is a good idea to check the measuring points indicated in the circuit diagram.

Should you want to use the generator to provide only one, fixed, output frequency—e.g. for distortion measurements—, it is certainly worth while to replace the P-C₁...C₁₂ filter with a higher order type to attain an output distortion of about 0.01%. It is readily seen that such a filter is considerably more com-

plex, and also more difficult to track with the generator output frequency, than the proposed single R-C combinations, and that is why it was left out of the present design.

It is possible to store waveforms other than a pure sine-wave in the EPROM. Do not forget, however, that the simple R-C low pass will cause distortion of sharp points of inflection present in, for instance, ramps and triangular waveforms. For these applications, a very complex DAC output filter is required, making the digital approach to signal generation cumbersome as compared with conventional analogue techniques.

St

6

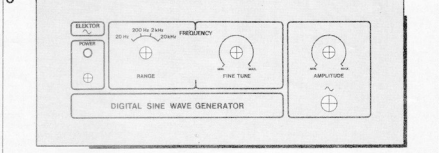

Fig. 6 The front panel foil for the digital sine-wave generator.

THE RAZOR EDGE OF THE EXCIMER LASER

by Dr Malcolm C. Gower, Laser Division, Rutherford Appleton Laboratory, Chilton near Oxford

Excimer lasers produce extremely intense bursts of ultraviolet light. Their ability to do so is generating a great deal of interest in areas as diverse as chemical synthesis, defence, surgery, and semiconductor processing and chip manufacturing. The short-wavelength photons they produce have enough energy to break most of the chemical bonds that bind molecules together, thereby fragmenting or simulating them to change their form. This ability to control the chemical state of matter and change it in a desirable and very selective way is at the heart of many of the most exciting applications of excimer lasers.

The most common type of excimer laser uses molecularly diatomic rare-gas halides such as ArF, KrF, XeF or XeCl as the active species from which the laser light is produced (see *Spectrum 161*). In their common, unexcited form, atoms of the rare gases Ne, Ar, Kr and Xe are unreactive or inert and do not readily form molecules. But if an electron is knocked off an atom to ionise it, the atom can become extremely reactive and form molecules, particularly with negative halogen ions of the F, Cl, Br and I types which have an additional electron attached to them.

Rare-gas halide molecules are held together by electrostatic forces, similar to the way alkali halide (salt) molecules are formed, as in the first illustration (a).

Because of their transient nature, with a lifetime of a few billionths of a second before falling apart by spontaneously

emitting ultraviolet photons, rare-gas halide molecules cannot be bought in a bottle but must be created in the laser vessel *in situ*. It is usually done by high-voltage electrical discharges in gas mixtures of halogen-bearing molecules and rare-gas atoms, as in part (b) of the illustration. The unexcited rare-gas halide molecules which form the lower laser level are unstable, so at any instant there are very few of them in the laser vessel.

Nearly all the rare-gas halide molecules in the vessel are excited and have energy available for extraction as ultraviolet laser photons. The wavelength of the laser light is determined by the type of molecule created and can be selected simply by changing the gas mixture originally added to the laser tube, as shown in the table, the pulsed energies of the light obtainable from typical commercial excimer lasers are also listed. Such devices can produce pulsed bursts of light lasting approximately 2×10^{-9} second at up to 500 times a second.

Nuclear fusion

Much larger excimer lasers can be built in the laboratory. A KrF laser at the Los Alamos National Laboratory, USA will soon be producing four terawatts (4×10^{12} watts) of ultraviolet light. This power is several times more than the combined capacity of all the electricity generating stations in the world today, but the laser can produce it for only about 5×10^{-9} of a second. With the aim of eventually building a laser-driven

nuclear fusion power plant for the relatively cheap pollution-free production of electricity, this extremely large laser is being used to study the nuclear fusion reactions produced when the focused laser light illuminates, heats and compresses to high density tiny glass microspheres containing deuterium and tritium gas.

To obtain more fusion energy from the pellets than is put into it by the laser light the plasma created should last for at least 2×10^{-8} second and have a temperature close to that on the Sun (10^6 degrees) while maintaining a density more than 50 times that of solids. Experiments have shown that such high temperatures and densities are more readily achieved by using short-wavelength ultraviolet laser light to irradiate and compress the target. Because excimer lasers can efficiently convert electricity to pulsed bursts of ultraviolet photons (conversion efficiencies of over 10 per cent have been demonstrated) and can in principle do so many times a second, they are considered to be the most likely driver source for any laser-induced fusion power plant which may eventually be constructed.

Semiconductors

The ability of ultraviolet excimer laser light to break molecules apart so easily is now being exploited in the semiconductor industry. For example, highly uniform conductive metal coatings can be deposited on the component surfaces of a silicon chip by using the laser to release metal

atoms from gaseous molecules above the surface. This step in silicon chip fabrication is called chemical vapour deposition and is conventionally done by means of plasma techniques, which in general are far more destructive to the silicon wafer and less controllable than the laser technique. Thin crystalline layers of silicon can also be grown by depositing atoms of silicon. Furthermore, by simultaneously locally melting the silicon wafer with an excimer laser, the technique can be adapted to implant dopants into the bulk silicon. Such implantation is used to create the p or n junctions which combine to form the minuscule circuit elements in the chip.

Present non-laser methods of implanting dopants into silicon by ion bombardment in plasmas tend to leave the silicon crystal lattice damaged, so it is essential to recrystallise (anneal) the silicon wafer in a high-temperature area. Apart from adding another slow step to the production process, high-temperature annealing of the whole wafer can also lead to distortions of the circuit elements on the chips. On the other hand, the excimer laser method of implanting can simultaneously locally anneal the silicon wafer as well as achieve very high, supersaturated concentrations of dopant atoms.

There is another process, too, in producing silicon chips, that can be improved upon by the excimer laser. Extremely small, complicated circuit patterns to be fabricated on the silicon wafer are initially laid out by reproducing master mask patterns of the silicon on a thin,

-	Wavelength (nm)	Energy/Pulse (mJ)
F ₂	157	40
ArF	193	500
KrF	249	1000
XeF	351 353	500
KrCl	222	100
XeCl	308	500

The wavelength of light produced by an excimer laser depends upon the type of molecule created. It can be selected simply by changing the gas mixture originally added to the laser tube, as in the left-hand column. In the right-hand column are the pulsed energies of the light obtainable from typical commercial excimer lasers.

light-sensitive plastic polymer film called the photoresist, coated on to the silicon. In a way similar to that in which a camera works, lenses or mirrors project an image of the illuminated mask on to the photoresist. In the exposed, bright regions of the mask pattern the photoresist is then removed by chemical development. Ions are subsequently implanted into the silicon through the gaps in the photoresist. This process of optical replication of mask patterns on to the silicon wafers is known as photolithography; incoherent lamp sources illuminate the mask. Recently, however, ultraviolet excimer laser light sources have demonstrated several unique advantages over lamps in such work. The most striking advantage is that the laser can produce images which are nearly 10^9 times brighter than those produced by a lamp. This means that the exposure time of the photoresist can be made negligibly small, allowing a substantial increase in the chip throughput of a photolithography machine. Furthermore, because the wavelengths pro-

duced by excimer lasers are in general shorter than those produced by high-powered lamps, smaller feature sizes on the mask can be replicated on to the chip. This allows many more, smaller circuits to be packed on to the chip, so that each chip can perform a greater number of operations at a greater speed. Another advantage of the excimer laser is that the extremely short burst of ultraviolet photons can also directly remove (etch or ablate) the photoresist from the exposed regions without the need for wet chemical development. So the excimer laser source may mean cutting out another processing step in chip production.

Clean etching

Ultraviolet excimer laser light directly etches plastics materials by producing a micro-explosion through efficient, rapid breaking of the chemical bonds that hold the polymer together. Unlike lasers working at longer wavelengths, the excimer laser produces no

melting and very little heating of the surrounding unexposed material, so that remarkably steep cleanwalled cuts are produced in the crater left behind. This type of clean etching also applies to biological tissue. The possibility of performing extremely clean cuts without charring and damage to surrounding tissue has aroused a great deal of interest in medical centres around the world.

The first study of a medical application of excimer lasers was to do with cutting and reshaping cornea tissue in the eye. Unlike light of a longer wavelength, ultraviolet radiation does not pass through the cornea layer at the front of the eye. In an operation known as radial keratotomy, pioneered in the Soviet Union, a diamond knife is used to make radial incisions in the cornea. Because the cornea as well as the lens can focus light, a change in its radius of curvature can lead to a permanent correction of defects caused by the lens, such as short sightedness. It has recently been shown that masking techniques enable this type of surgery to be done by means of an excimer laser, with a quality and precision far exceeding that achieved with a knife. Moreover, the laser can reshape the cornea by machining rings and crescent shapes. It can also make the precise incisions necessary for subsequent corneal transplants or removal of cataracts.

Balloon angioplasty

Work is also going on to investigate the use of the excimer laser to unblock arteries, a procedure known as angioplasty. Blockage near the heart by accumulation of plaque, the condition known as atherosclerosis, eventually leads to a heart attack. Most widespread of surgical methods now used to alleviate this condition is extremely invasive open-heart surgery, in which surgeons bypass the blockage by grafting a new artery around it. Less invasive is a recently developed technique called balloon angioplasty, in which a fibre is threaded through the arteries to the blockage and a balloon on the end is then inflated to open it out; the patient remains conscious throughout. But the technique can also damage arterial

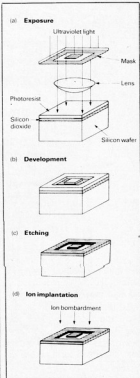

The successive steps in photolithography, a process used in the semiconductor industry for making chips.

tissue. An alternative method might be to use light from an excimer laser, passed down through an optical fibre in the artery, to burn through the blockage cleanly. Initial studies have shown that for soft, non-calcified plaque the excimer laser can remove the constriction efficiently and cleanly. Calcified blockages are much more difficult to remove.

Among other medical applications being studied are very precise neurosurgical cutting in the brain and spinal column. While most applications of high-power visible and infrared lasers use the laser merely as a sophisticated cutting and welding torch, the most exciting potential applications of excimer lasers make use of the high powers which they are capable of producing and the ability of the ultraviolet photons to induce changes in the chemical state of matter in a most efficient way. Many new applications of excimer lasers may be expected to develop as scientists and engineers become increasingly aware of their tremendous potential.

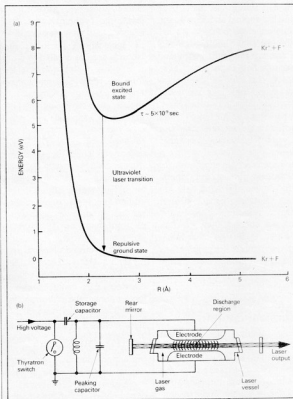

(a) Simplified energy potential curve for KrF excimer molecule, showing energies plotted against the internuclear separation R. (b) The features of an excimer laser.

VLF ADD-ON UNIT FOR OSCILLOSCOPES

This is a low-cost storage unit enabling oscilloscope users to view signals with very long periods. Where the typical oscilloscope merely shows a slowly travelling spot in response to a VLF input signal, this add-on unit is intended to convert that instrument into a versatile chart recorder.



The bandwidth of an oscilloscope is generally considered one of its main technical characteristics. For obvious reasons, the relevant specification is generally featured close to the oscilloscope type indication on the front panel. Interesting as its bandwidth specification may be, the common oscilloscope can not offer what appears to the user to be a continuously written trace, at input frequencies below some 10 Hz.

The vast majority of oscilloscopes is totally unsuited to study a process with a period time of, say, one minute. Even in the unlikely event of the instrument offering a timebase setting of 0.01 Hz/div, nothing would be visible on the screen, other than an apparently stationary, bright spot. In this example, a usable curve can only be obtained from a special chart recorder, or a storage oscilloscope, both of which are relatively costly instruments.

The VLF add-on unit described in this article considerably extends the lower end of the bandwidth of any oscilloscope having a timebase setting of

500 μ s/div, an external trigger input, and a positive edge trigger selection. Its input impedance must not be less than 1M Ω . Actually, there should not be too many oscilloscopes around which do not meet these requirements!

In essence, this oscilloscope extension is an 8-bit wide memory block inserted between an analogue-to-digital converter (ADC) at the input, and a digital-to-analogue converter (DAC) at the output. Its wide range of available timebase settings—see the Techni-

cal Specifications Table—enables the storage unit to be used for applications like studying the thermal behaviour of systems, analysing subsonic movement, or establishing charge and discharge curves of batteries. In the former two examples, a suitable sensor (temperature-to-voltage converter; strain gauge) plus associated amplifier could be used to drive the storage unit. After the measuring process is completed, the user can view a neat curve on the oscilloscope screen for closer analysis. Dur-

ing the measurement, the writing of the curve can be observed without a trace of display flicker, as the oscilloscope is set to a sufficiently high display rate.

If you are now under the impression that the present storage unit incorporates a fair number of costly components in a highly complex circuit, it is time to proceed reading the next section.

Block diagram

Fig. 1 shows the basic operation of the circuit during its two alternating states of digitizing U_m (CONVERT) and outputting the sampled data to the oscilloscope (DISPLAY).

Digitizing of U_m is essentially done on the basis of *ramp and compare*. The output of an 8-bit counter, IC₁-IC₈, is translated into an analogue voltage by a DAC (digital-to-analogue converter), which produces a ramp output signal for comparison with U_m in IC₉. As soon as U_{out} from the DAC rises above U_m , IC₁₀ toggles, and the lastly present data from IC₁-IC₈ is written into the RAM location ad-

VLF storage unit

Technical Characteristics:

- Timebase settings: 5 s/screen; 12.5 s/screen; 25 s/screen; 50 s/screen; 125 s/screen; 250 s/screen; easily extendable as required
- Input sensitivity: 200 mV/div.
- Trigger output swing: 5 V_{pp}.
- Input voltage range: 0...2 V; DC-coupled.
- External supply: 5 V at 100 mA.
- RESET to clear screen.
- FREEZE button to retain image.
- Operates with virtually any type of oscilloscope.

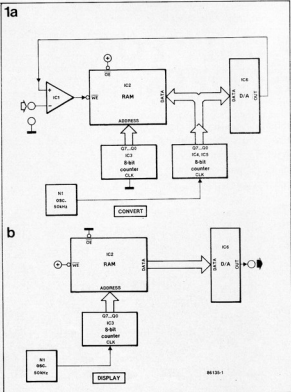

Fig. 1 Basic circuit operation during a convert cycle (1a) and a display cycle (1b).

pressed by IC₁. In this manner, the stored data by IC₂ is the digital equivalent of the instantaneous level of U_{in}. Note that IC₂ addresses one RAM location only during the CONVERT mode, as its CLK input does not receive address count pulses. During the DISPLAY mode, IC₂ is arranged to successively address all the 256 bytes in the RAM, whose contents are fed to the DAC providing the scope with the restored analogue level of U_{in}.

The cost-effective use of IC₅ as a DAC and—along with the 8-bit counter and the comparator—as an ADC requires a rather particular circuit timing, which will be examined below.

Circuit description

The circuit diagram of the VLF storage unit, and its basic internal timing arrangement, are shown in Figs. 2 and 3, respectively.

Assuming the circuit to operate in the CONVERT mode, gate network N₁-N₂ disables address counter IC₃ from receiving 50 kHz clock pulses from N₁. The address inputs of RAM

(random access memory) IC₂ are, therefore, held at a fixed logic configuration, causing the rising, 256-increment, binary value from counter and latch IC₄-IC₅ to be written to one memory location only. Note that IC₂ is a 2048-byte RAM, whose memory capacity has been restricted to 256 bytes by grounding its A₈...A₁₀ inputs. The Type 6116 was chosen because it is much cheaper and easier to obtain than, for instance, a S101 256 x 8 RAM. The Type ZN426 8-bit DAC thus outputs the analogue equivalent of the output states of IC₄, i.e., a ramp is obtained to drive the + input of comparator IC₁ (see Fig. 3, curve IV), while U_{in} is applied to the protected - input.

As already explained, the opamp output remains low as long as U_{out} from the DAC is lower than U_{in}. Output Q of bistable FF₁ drives the WE (Write enable) input of IC₂ low, so that each binary value from counter IC₄ is stored and overwritten again at the current address obtained from IC₃. Only that counter state from IC₄ that causes U_{out} from the DAC to be higher than U_{in}, is left at the rel-

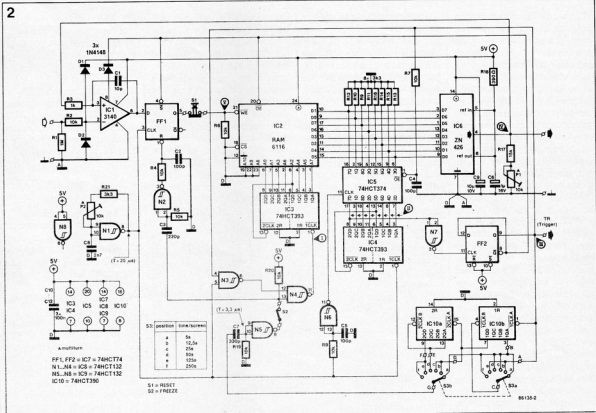

Fig. 2 Circuit diagram of the storage add-on unit.

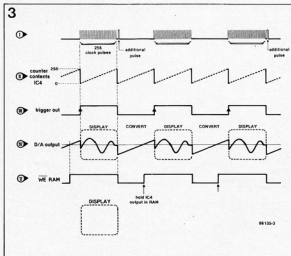

Fig. 3 Essentials of the pulse timing in the circuit.

event address, as WE goes high immediately afterwards, disabling the writing of further data in the RAM—see Fig. 3, curves IV and V. Obviously, the lower the instantaneous level of U_{in} , the sooner IC_2 toggles, and the lower the value written into the RAM. This completes one conversion cycle.

After every 256 clock pulses from N_1 , N_2 supplies a positive pulse transition to the clock input of bistable FF_2 , which in response toggles to produce the trigger pulse for the oscilloscope, thus marking the start of the display cycle. The toggling of FF_2 ($Q=1$; $\bar{Q}=0$) causes a number of things to happen simultaneously. Output Q is used to enable the output drivers in IC_2 to pass the binary RAM contents to the DAC input lines. As $\bar{O}E$ of IC_2 is driven high by Q , no contention problems can arise. Also, the low level of Q is used to disable IC_1 by means of controlling its STROBE input, pin 8. Bistable FF_1 is set to prepare for the next toggle action during a conversion cycle. Output Q of FF_2 enables N_2-N_3 to pass the 50 kHz clock signal to the CLK input of address counter IC_3 , causing IC_2 to output all data contained in its 256 memory locations. It is important to realize that the first location addressed is determined by the start state of IC_3 ; as this counter is not reset, the state of its $1QA \dots 2QD$ outputs is simply frozen after Q of FF_2 goes low again. In order to be able to write to all 256 locations in IC_2 , an additional clock pulse is

needed to enable IC_3 to address the next higher RAM location where data will be stored during the CONVERT cycle. This pulse is obtained from two cascaded counters in IC_1 . After the RAM contents are written to the oscilloscope—i.e., after 256 clock pulses from N_1 , FF_2 toggles again to start a fixed edge of Q advances counter IC_1 one state. Depending on the setting of the time/screen switch, S_1 , a predetermined number of Q transitions must occur before N_3 can produce the previously mentioned additional clock pulse to have IC_3 point to the next higher location in the RAM—see Fig. 3, curve I. After a short delay caused by C_2-R_3 and C_2-R_4 , FF_1 is reset. The above timing arrangement effectively results in the oscilloscope screen being written from the right to the left, creating the impression of a fixed display window through which the signal can be observed to pass smoothly. The positive edge triggering of the scope ensures that only the DISPLAY phase of the DAC output waveform is shown on the oscilloscope screen—see curve IV.

Fig. 4 further illustrates the basic principle of the scrolling oscilloscope image. Although the writing of the data into the RAM is a relatively slow process—the write rate being the time/screen setting divided by 256—the RAM contents are displayed at such a speed as to ensure a stable image on the scope. The display window can

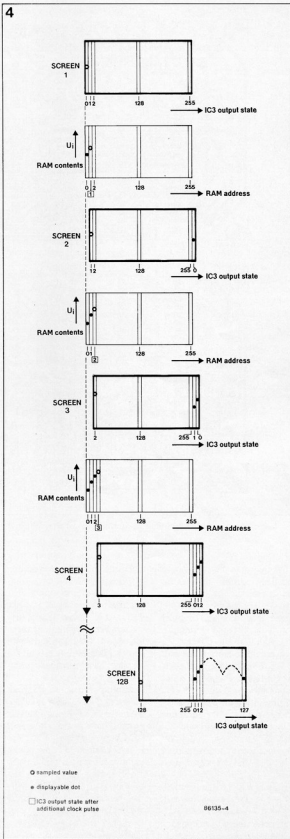
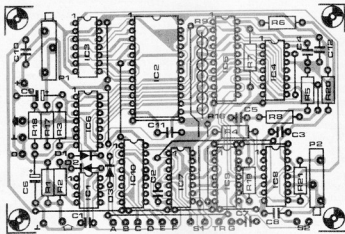
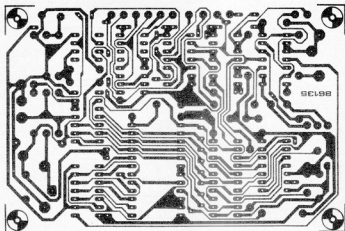

Fig. 4 Memory contents and screen contents. Note how the image is written from the right to the left.



add-on unit.

Fig. 5 Track layout and component mounting plan of the scope

move thanks to the start state of the RAM address counter being increased by one, after counter IC₁₀ has received a predetermined number of pulse transitions from the Q output of FF₁. Although the display window is seen to move to the right in Fig. 4, the actual situation is, of course, that the sampled curve moves to the left. The writing of sampled data can be observed as an additional bright dot appearing to the right of the screen, shifting the previously written image to the left. The instantaneous input voltage for the storage unit is visible as a spot to the left of the screen; at the moment it is written into RAM, the curve shifts one dot to the left, as shown in Fig. 4.

Pressing the FREEZE button inhibits the additional clock pulse from advancing IC₁, so

that the displayed image comes to a standstill, while the instantaneous value of the input voltage remains visible as a bright dot at the utmost left of the screen. Pressing RESET causes the RAM to be filled with zeroes, and hence clears the display for a new measuring period.

Returning to the circuit diagram, Fig. 2, delaying R-C networks have been fitted at several gate inputs. It would have been possible to arrange for a correct circuit timing with the use of, say, a multi-phase clock section, but the low frequencies involved fully justify the use of simple R-C combinations in the relevant positions. It should be noted, however, that the indicated R and C values are specifically dimensioned for HCMOS gates, making it impossible to use LSTTL

Parts list

Resistors ($\pm 5\%$):

- R₁ = 1M Ω
- R₂, R₄, R₈ incl.; R₁₀, R₂₂ = 10K
- R₃ = 1K Ω
- R₅, R₁₆ incl.; R₂₁ = 3K Ω
- R₁₇ = 15K
- R₁₈ = 330R
- P₁, P₂ = 10K multitrurn preset

Capacitors:

- C₁ = 10p ceramic
- C₂, C₄, C₅ = 100p ceramic
- C₃ = 220p ceramic
- C₆ = 1 μ , 16 V electrolytic
- C₇ = 330p ceramic
- C₈ = 2n7
- C₉ = 10 μ , 16 V
- C₁₀, C₁₁, C₁₂ = 100n

Semiconductors:

- D₁, D₂, D₃ = 1N4148
- IC₁ = 3140
- IC₂ = 6116
- IC₃, IC₄ = 74HCT393*
- IC₅ = 74HCT374*
- IC₆ = ZN426
- IC₇ = 74HCT74*
- IC₈, IC₉ = 74HCT132*
- IC₁₀ = 74HCT390*

* Do not use a LSTTL type.

Miscellaneous:

- S₁ = push to break button.
- S₂ = miniature SPST switch.
- S₃ = 2-pole, 6-way rotary switch plus knob.
- PCB Type 86135 (see Readers Services).
- ABS enclosure, e.g. Verobox Type 75 3007C (1180 x 120 x 40 mm).
- 3 off BNC sockets.
- Suitable socket for external supply connection.

It is regretted that the front panel foil for this project is not available through the Readers Services.

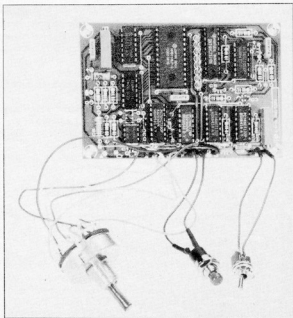

6

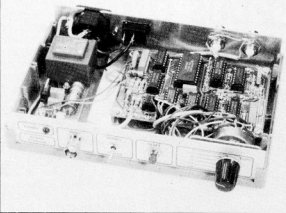
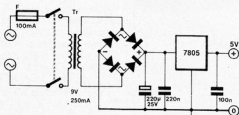

Fig. 6 Suggested construction in a Verobox enclosure.

7a



b

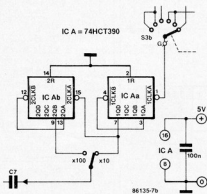

Fig. 7 Optional circuit extensions: a simple power supply (7a), and a $\times 10/\times 100$ timebase extender.

types without upsetting the circuit timing. The add-on unit does not comprise an internal supply, but this should not be too difficult to make, considering the modest current drain of 100 mA or so from a regulated 5 V supply.

Construction, alignment and extensions

The VLF add-on unit is constructed on a ready-made PC board Type 86135—see Fig. 5. While completing the board, do not forget to fit any of the wire links, and mount pull-down resistors $R_1 \dots R_8$ incl. vertically, joining their common ground connection with a horizontally running length of bare wire.

The introductory photograph of this article, and the one shown in Fig. 6, should offer sufficient details to be able to complete the unit successfully. The input and output connections of the storage unit are preferably made with BNC sockets, while the 5 V supply can enter the enclosure through a small DC supply socket as used in pocket calculators and portable cassette recorders. Plenty of space remains in the stated Verobox to incorporate a simple mains supply—Fig. 7a shows the circuit diagram of a suggested version.

Aligning the circuit is as easy as constructing it. Set the scope timebase to $500 \mu\text{s}/\text{div}$, and select negative-going, external triggering. Set the vertical sensitivity to $200 \text{ mV}/\text{div}$, or $20 \text{ mV}/\text{div}$ when using a $10:1$ probe. Select DC input coupling. These settings enable the scope to show the conversion cycle, rather than the display cycle as used normally. Do not apply an input voltage to the

add-on unit. The scope should show one period of the ramp output from DAC ICs. Use the X and Y position controls of the scope to move the start of the slanting line to the lower left hand corner of the display graticule, then adjust P_1 and P_2 to make the upper end of the curve coincide with the top right hand corner of the graticule. This sets the DAC output for a peak-to-peak excursion of 2 V, at a ramp duration of 5 ms. For normal operation of the storage unit, the scope must be set as during the alignment, but with **positive** external triggering selected.

Finally, the sample time of the proposed storage unit may be extended as required by adding a divider in series with the connection between the pole of S_{3b} and C. Fig. 7b shows a suggested extension circuit to lengthen each of the time/screen settings by a factor 10 or 100. With this one-chip extension, the maximum attainable sampling period is no less than $250 \times 100 = 25,000$ seconds, or about 7 hours.

Th

8

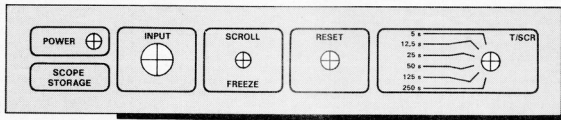

Fig. 8 Suggestion for a front panel foil for the VLF storage unit.

ROM/RAM CARD FOR ELECTRON PLUS ONE

Here is a 32 Kbyte ROM and/or RAM extension module which plugs straight into the Plus One cartridge slot. In other words: extra memory for the baby brother of the BBC-B micro!

Many programs available for the Acorn Electron microcomputer come in the form of ROMs (read only memory chips) to go round the problem of having to load the program in the limited RAM space available. These ROMs either start up immediately after power-on, or they can be accessed by means of a particular user command. ROMs are generally classified as Service (S) ROMs, Language (L) ROMs, or a combination of these, S/L-ROMs.

Although it would be beyond the scope of this article to expound the intricacies of ROM filing, priority assignment, and identification strings, it is none the less useful to consider the memory organization of the Electron micro fitted with a Plus One extension. Fig. 1 shows that the address range from 8000_h to BFFF_h can be used by four banks of 16 Kbytes, which are switched on and off as required by a suitable command from the ROM-resident Machine Operating System (MOS, top 16 K), which effectively controls the bankswitching procedures during a programming session. Except when L-ROMs are fitted in either one 16 K block in the cartridge, the Electron will run its BASIC interpreter after power-on, or, more precisely, after MOS has examined all add-on ROMs or RAMs for the presence of a language identification string. If this is encountered and found valid, the computer starts executing object code from the highest priority L-ROM, disabling the BASIC interpreter, but leaving the Plus One Utilities accessible through special commands. As to the amount of RAM (random access memory) in the Electron, there is no denying that the number of bytes available to hold a user program depends on the selected video mode, and the size of the system workspace. Obviously, when running programs in any

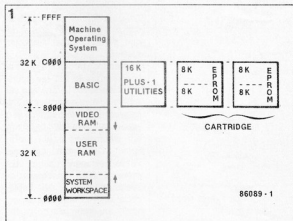
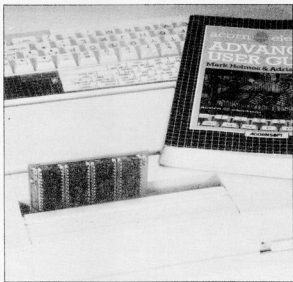

Fig. 1 Memory map of the Electron Plus One computer.

of the high-resolution graphics modes of the Electron, the user space gets rather tight, as up to 20 Kbytes of RAM are reserved for the video processor. To create more memory space for the user, the proposed extension card can hold a maximum of two banks of 16 Kbytes of sideways RAM. It is also possible to install one 16 Kbyte EPROM and two 8 Kbyte RAMs to make for an even more versatile set-up. For instance, copy-

ing ROMs to RAM, or moving large buffer areas to sideways RAM (video applications!) is no longer problematic.

A good deal more information on the internal organization, and insiders' methods of using the full capability of the Electron, can be found in the *Advanced User Guide*, by Mark Holmes and Adrian Dickens. This book is recommended as an indispensable supplement to the *Acorn Electron User*

Guide, which typically falls short of information on those technical aspects of the micro that are necessary to get the most out of it.

Circuit description

The circuit diagram of the ROM/RAM card is shown in Fig. 2. The Plus One bus signals (see Fig. 3) are fed to the extension circuitry via the slot connector shown to the left of the diagram.

Two wire jumpers are used to select between 16 K ROMs and 8 K RAMs in the IC₁ and IC₂ positions. Gates N₁ and N₂ provide for a correctly timed WR (write) pulse for the RAMs, while N₃...N₆ are used to divide the memory space within the cartridge into four blocks of 8 Kbytes, which can either be assigned to two ROMs (2 × 16 K), or to four RAMs (4 × 8 K), or to one ROM and two RAMs (16 K + 2 × 8 K). Thanks to the internal AND function of CS1 and CS2 inputs of the Type 6264 RAM and the Type 27128 EPROM, the chip select circuitry on the card could be realized with only a few gates. Table 1 shows the address assignment and the various chip combinations of the memory extension card. When using L-ROMs, observe that IC₂ has a higher boot-up priority than IC₁.

Construction

The ROM/RAM extension is extremely simple to build on through-plated, double sided board Type 86089. Fig. 4 shows the component overlay. While soldering the IC socket pins, do not apply too much solder on penalty of creating a troublesome hardware bug. Also, make sure that decoupling capacitor C₁ does not cause a short-circuit on any of the three tracks running underneath it. Pins 1 of the memory chips have been inter-

connected. With some types of (EP)ROM, it may be necessary to connect the pin 1 line to the positive supply rail, running right next to it (pin 1 of a 27128 is the programming voltage input, while it is *not connected* with a 6264 RAM).

Fit the wire links or the jumpers as required for your specific memory configuration, and finish the construction with plugging in the ICs, observing the correct orientations.

Install the board in the cartridge slot in the Plus one extension, and note that the track side of the PCB faces the keyboard, that is, the ICs on the ROM/RAM card must face the rear side of the computer. It is a good idea to stick small, clearly lettered adhesives on either side of the board to prevent plugging it in the wrong way about.

Testing and using the extension

The Plus One extension assigns ROM block numbers 0 and 1 to the rear slot, and block numbers 2 and 3 to the front slot, as viewed from the keyboard. Each block is a 16 Kbyte memory area. The test program listed in Table 2 will check for the presence of correctly operating RAM in the far and/or near extension slot on the Plus One extension.

The essential operation of this "assembler-in-BASIC" routine is as follows. In line 60, the ULA inside the Electron is fed with a dummy byte 14h to pass the bank switching control to the program. Register FE05h is a R/W location internal to the ULA, and great care must be taken in accessing it, as it also comprises interrupt control bits. The 16 Kbyte blocks are each examined as to their

2

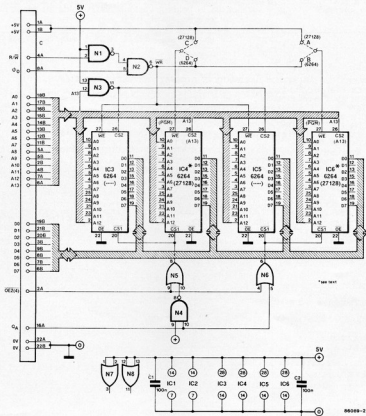

Fig. 2 Circuit diagram of the 2x16 Kbyte ROM/RAM extension.

ability to be read from and written to without modifying the original memory contents. This is done in a number of nested loops, wherein sideway RAM bytes are copied into a 6502 zero-page location, inverted, stored and loaded again, and checked against the original

byte. In this way, correct R/W accessibility of the entire 16 K RAM area is checked on a byte-by-byte basis. After initialization lines 30 to 70, the program fetches the first byte, inverts it by means of a EOR FFh instruction, and stores the obtained result back into the RAM, as well as in

Table 1.

Jumper	RAM only		(EPI)ROM only		RAM & (EPI)ROM		RAM & (EPI)ROM	
	BLOCK 1 or 3	BLOCK 0 or 2	BLOCK 1 or 3	BLOCK 0 or 2	BLOCK 1 or 3	BLOCK 0 or 2	BLOCK 1 or 3	BLOCK 0 or 2
BFFF	D	B	C	A	D	A	C	B
A000	IC ₁ RAM	IC ₂ RAM	1/2 IC ₃	1/2 IC ₄	IC ₁ RAM	1/2 IC ₂	1/2 IC ₃	IC ₄ RAM
9FFF	IC ₁ RAM	IC ₂ RAM	Do not fit IC ₃ , IC ₄		Do not fit IC ₁		Do not fit IC ₃	
↑ 8000	IC ₁ RAM	IC ₂ RAM	1/2 IC ₃	1/2 IC ₄	IC ₁ RAM	1/2 IC ₂	1/2 IC ₃	IC ₄ RAM

Far slot = blocks 0 and 1

Near slot = blocks 2 and 3

(as viewed from keyboard)

3



Fig. 3 Pin assignment of the Plus-One slots.

the zero-page location 0073h. Finally, the RAM byte is compared with the one at 0073h to check for a matching bit-configuration. If this is successful, the original byte in

RAM is restored by once more inverting the accu contents and writing it to the location in the extension. This loop-and-test function is executed in line 80. Location 0071h holds a vector

address pointing to the RAM location, which is automatically incremented with the aid of the Y (index) register available in the 6502 processor. Location 0072h holds the block number

(00...0F), while location 007F is used to hold an error flag byte, FFh.

Returning to the loop in in line 70 it is seen that RAM errors cause the program to jump to line 110 where the error flag is set, and the faulty address is written into location 0070h. In line 120 bank switching control is returned to the ULA, and BASIC is restarted. Each page—256 bytes—in the extension memory that is successfully tested is identified with a + sign written onto the screen. In this way, defective or non-present RAM pages can be singled out at a glance.

The test run below the listing in Table 2 was performed with the ROM/RAM card fitted with RAMs in the IC₁, IC₂, and IC₃ positions. The card was inserted in the front slot (blocks 2 and 3). At power-on, the computer ran its BASIC interpreter as normally, since no L-ROMs were detected during the system boot.

Running the RAM test program immediately showed that the upper half of block 3 was found faulty, which is not surprising in the absence of IC₃ (consult Table 1 once more). (EP)ROMs, of course, also produce a "no RAM at <block number>" message.

It must be remembered that the extension memory is only accessible through machine language subroutines; this is because the BASIC interpreter uses the same 16 Kbyte memory area. You may want to study the previously discussed test program a little closer to be able to write your own subroutines for the creation of background memory or for access to subroutines in proprietary ROMs. With the proposed ROM/RAM card, you will have no difficulty in running commercially available L-ROMs such as LISP, FORTH, LOGO etc., while utilities such as VIEW, editor/assembler packages, and games ROMs can be plugged in to considerably add to the versatility of the Electron Plus One computer.

Table 2.

```

10 MODE3:CLS:PRINT"NON-DESTRUCTIVE SIDWAY RAM TEST":PRINT:PRINT:PRINT
20 REM Elektor Public Domain Software
25 REM By J Barendrecht
30 ?&7#0: ?&7F#0: ?&72#0
40 DIM OK 255
50 FOR I=0 TO 2 STEP 2:PK#OK:LOPTI
60 .TEST SEI:LDA#14:STA#F4:STA#FE05:LDA#72:STA#F4:STA#FE05:LDY#0
70 LDA#80:STA#71
80 .LOOP LDA($70),Y:EOR#255:STA($70):STA($70),Y:LDA($70),Y:CMP#73:BNE error
90 EOR#255:STA($70),Y:INY:BNE LOOP
100 .NXT LDA#32B:JSR#FFE3:INC#71:LDA#C0:CMP#71:BNE LOOP:JMP FINI
110 .error LDA#8F:STA#7F:ST#70
120 .FINI LDA#10:STA#F4:STA#FE05:CLI:RTS
130 INEXT
140 CALL TEST
150 IF?&7#0 AND ?&71=120 THEN PRINT"NO RAM AT "?&72:GOTO 100
160 IF?&7F=255 THEN PRINT"** ERROR AT **"?&72:GOTO 100
170 PRINT"TEST OK AT ",?&72
180 IF?&72<15 THEN ?&72=?&72+1: ?&7F#0:GOTO 140
190 PRINT:PRINT:PRINT:PRINT:"END OF TEST"
200 END

```

>RUN
NON-DESTRUCTIVE SIDWAY RAM TEST

```

NO RAM AT      0
NO RAM AT      1
*****TEST OK AT 2
***** ERROR AT **      3
NO RAM AT      4
NO RAM AT      5
NO RAM AT      6
NO RAM AT      7
NO RAM AT      8
NO RAM AT      9
NO RAM AT     10
NO RAM AT     11
NO RAM AT     12
NO RAM AT     13
NO RAM AT     14
NO RAM AT     15

```

END OF TEST

86089 - T2

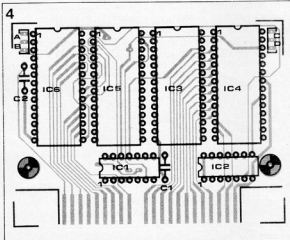

Fig. 4 Component mounting plan for the ROM/RAM board.

Parts list

Capacitors:

C₁, C₂ = 100n

Semiconductors:

IC₁ = 74LS00

IC₂ = 74LS32

IC₃ = 6254**

IC₄ = 6254 or 27128*

IC₅ = 6254**

IC₆ = 6254 or 27128*

* Access time 200 ns or faster

** See text for memory configuration details.

Miscellaneous:

jumpers and associated blocks for

links A...D incl.

PCB Type 86089 (see Readers Services).

This memory extension board has been designed and developed with the permission of Acorn Computers Ltd. Ed.

SOFTWARE FOR THE BBC COMPUTER — 3: PCB DESIGN

Third in the series, this article looks at designing printed circuit boards with the aid of an artwork production package.

Pineapple Software of Ilford, Essex, are the suppliers of *PCB*, a software package intended to make high-quality artwork for the direct production of printed circuit boards (PCBs). The program comes as a sideways ROM, a disk, and a reference manual. In essence, *PCB* is a high-resolution draughting program, capable of outputting layouts to a draft quality printer. The maximum size of a circuit board that can be designed is 10 cm x 16 cm, being the standard Eurocard format. *PCB* fully supports the making of double-sided boards, and uses different colours for the tracks on each side of the board. *PCB* is not an auto-routing program, which means that it can not automatically decide on the most efficient track route between roundels. The user of *PCB* draws the track-layout on screen with the aid of the cursor positioning keys, placing roundels at the required locations. Before being able to do this, however, the component mounting plan must be designed.

Making a component mounting plan

After specifying the overall size of the board required, the screen displays its outline and a number of standard component shapes, which may be expanded as required to provide an easy way of handling, for instance, various sizes of DIL enclosure. Components are "picked up" and located in the desired position on the PCB. They can be interchanged, moved about, and identified with part numbers until the component placement is thought satisfactory. Roundels are automatically placed on a 0.1-inch invisible grid, and the

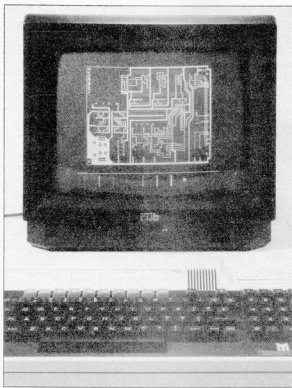

cursor moves with a corresponding precision, except during the line drawing mode, when it moves in 0.025-inch-steps.

Unfortunately, *PCB* does not enable users to create their own library of frequently used component shapes. On completion of the component mounting plan, this can be stored onto disk.

Making the track layout

After loading the component mounting plan from disk, *PCB* removes the component outline shapes from the screen, leaving only the roundels present. A new selection of options is

presented to the user. At a first glance, the track layout on screen looks rather coarse. Especially when tracks are run in between IC pins, it often looks as if a short-circuit exists. Three track widths are available: 0.025 inch, 0.05 inch, and 0.075 inch, but wider tracks are easily made with the flood fill facility, which also allows large copper surfaces to be designed with a single user command. As during the component placing phase, the cursor positioning keys are used to move across the screen, while the part numbers may be "called up" for reference, and the display of either side of the board may be removed temporarily to make track routing clearer on complex boards. Further routines

available during the track layout design phase include circle drawing, partial and complete deletion of tracks—irrespective of the complexity of the route—, component identification in four possible orientations, roundel placing at both PCB sides to prepare for through-plating, and returning to the component mounting plan to move groups of roundels.

Artwork printing

The previously mentioned fear of *PCB* being too inaccurate to cope with very close running tracks is quite unfounded considering the astounding precision of the final artwork produced by the printer. To test the performance of *PCB*, we set out to design a circuit board for a 6809 CPU card. Fig. 1 shows some intermediate results while working with *PCB*. The print-outs were obtained with an Epson FX80 printer. The precision of the true-scale track layout on draft-quality paper is sufficient to be able to use it for the production of a transparent film.

The print routine in *PCB* is run from the supplied ROM. A good quality printer must be used for optimum precision; Pineapple mentions that it must be *Epson FX compatible*, which means that it should switch to quadruple density graphics printing when receiving an ESCAPE-Z code from the computer.

Conclusions

PCB is a fine tool to design one's own circuit boards. With some experience in making PCB artwork, the program is well suited to producing high-quality layouts at reasonable speed. The final accuracy of the

1a

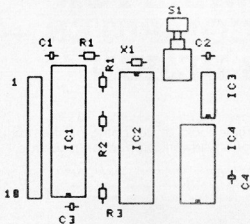

Fig. 1a The first design stage: making the component mounting plan.

1b

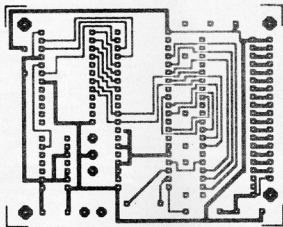

Fig. 1b Intermediate print-out of the track pattern made with PCB.

printout is probably hard to beat using a completely manual design method. Therefore, *PCB* should appeal to both the advanced electronics hobbyist and the manufacturer of small series of PCBs for a specific project.

Pineapple Software are in the good habit of supplying free update service for their packages, thus ensuring that the registered user is always in possession of the best working version of the program. Each ROM supplied by Pineapple holds a user-specific, hidden registration code to be able to trace down the original owner of a ROM when discovering "roque" copies.

A final note concerns the previously mentioned auto-routing facility. It is our understanding that Pineapple will shortly announce an enhanced version of *PCB* allowing the computer to do the drawing of the tracks automatically once the component locations on the circuit board have been established. Meanwhile, the standard version of *PCB* is available at £85.00 + VAT, from

Pineapple Software
39 Brownlea Gardens
Seven Kings
Ilford
Essex IG3 9NL.
Telephone: (01 599) 1476.

The next instalment in this series will deal with two programs for analogue circuit analysis. St

micro-squeaker

This circuit is by way of being an electronic joke. The complete circuit comprises only one transistor, one capacitor, a miniature transformer and a headphone. The transistor can be any germanium type; the transformer can be any miniature type with a turns ratio between 3:1 and 10:1. At supply voltages as low as 0.2 V the headphone produces a distinct sound. Current consumption is then of the order of 10 μ A, power consumption is less than 2 μ W. The joke

of this microsqueaker is that it is not fed from a 'normal' current source, but that the gifts of nature are called upon. The positive connection is a piece of bare copper wire, the negative connection is a bare piece of steel or silver wire. If both ends are stuck into an apple, a lemon or a potato, at some distance from each other, the apparatus produces a tone. A

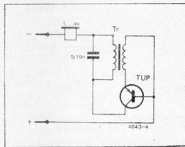

solar cell could also serve as the voltage source. The squeaker may also be used as an indicator for D.C. voltages in the range of 0.2 V ... 10 V.

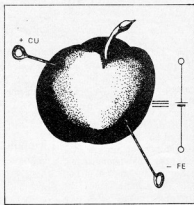

FIELD-EFFECT OPTOCOUPLER

by W Teder

In this article we will examine a number of possible applications of a recently introduced optocoupler incorporating an infra-red light-emitting diode and a phototransistor made in field effect technology.

In spite of its many interesting applications in the field of audio engineering, the Type H11F3 FET optocoupler from General Electric (GE) has so far passed unnoticed to many hobbyists and professional designers eager to experiment with new semiconductors.

Apart from its use as a fast, electrically isolated switch (solid-state relay), the H11F3 is eminently suitable for quite a number of applications having to do with AF signal processing. Table 1 shows the maximum ratings of the FET optocoupler, while Fig. 1 shows its pin assignment and its equivalent circuit diagram. The field-effect element in the H11F3 is a non-polarized, photo-sensitive semiconductor layer, comparable to a drain-source junction. This semiconductor essentially behaves like a light-controlled resistor, whose resistance is a function of the current passed through the IR LED in the package. The H11F3 offers a remarkable resistance range of 100 ohms to 300 mega-ohms.

Many applications

In this section we will offer a necessarily brief discussion of a number of application circuits based on the new optocoupler. These applications come under two headings: the use of the H11F3 as a controllable resistive element, and its use as a fast, isolated switch.

Before introducing a number of applications in the first mentioned category, it must be pointed out that the FE element in the H11F3 behaves largely similar to a normal drain-source junction. Therefore, the voltage across R_r must not exceed some 50 mV to avoid distortion. Fig. 2 shows the basic concept

of a controlled voltage divider, whose main feature is an unusually low charge injection cross-talk figure. Fig. 3 is a more practical application of the use of the FET optocoupler in a design for a compressor, whose attack, decay, and rate of compression are individually adjustable. The limiter shown in Fig. 4 is based on the use of a comparator circuit which drives the IR LED in the optocoupler whenever the AF input voltage exceeds a preset value. As with the compressor, the attack and decay times can be defined over a wide range.

When designing circuits incorporating a number of optocouplers driven from a common control line, due account should be taken of the fact that the values of R_r of the individual resistive elements need not be identical, even if the same amount of current is passed through the associated infra-red emitting diodes—see Fig. 5. It is, therefore, not recommended to use H11F3s in tracked VCAs, or synchronously tuned active filters. Fig. 6 shows how adjustable current sources can be used to match R_r of two optocouplers. The cir-

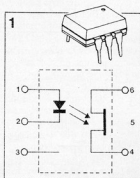

Fig. 1 Equivalent circuit and pin assignment of the H11F3 field-effect optocoupler.

Table 1.

H11F3 Maximum ratings:

IR diode:

I_{max} (continuous)	60 mA
I_{max} (peak)	500 mA ($t \leq 500 \mu s$)
	1 A ($t \leq 1 \mu s$)
Dissipation	150 mW (at $T_a = 25^\circ C$)

FET:

U_{DF}	$\pm 15 V$
JRF (continuous)	100 mA
Dissipation	300 mW (at $T_a = 25^\circ C$)

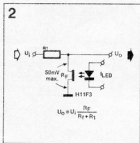

Fig. 2 Rudimentary form of an AF attenuator.

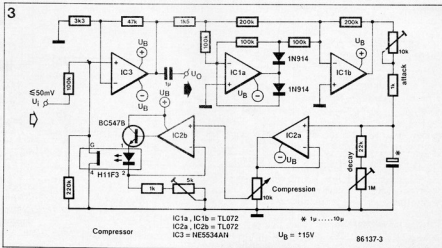

Fig. 3 The new optocoupler as the regulating element in a compressor circuit.

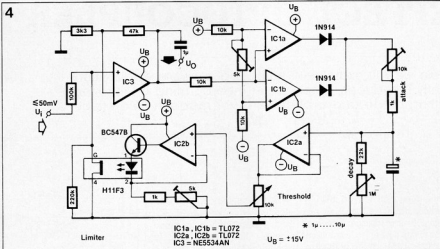

Fig. 4 A variable-threshold AF limiter.

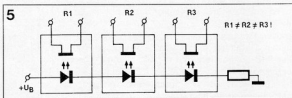

Fig. 5 The IR diodes connected in series for multi-channel regulation purposes.

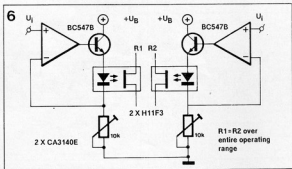

Fig. 6 Adjustable current sources are used to match the LED-Rf characteristics of two optocouplers.

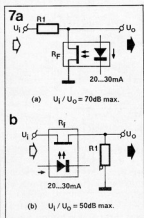

Fig. 7 Basic AF switch configurations.

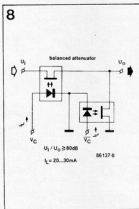

Fig. 8 Improving the U_1/U_O ratio by using a combined series and parallel switch.

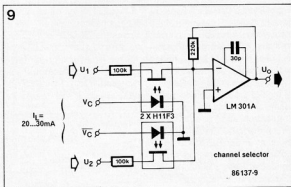

Fig. 9 A click-free two-channel audio input selector.

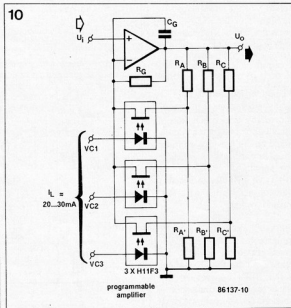

Fig. 10 Using the FE junctions in 3 H11F3s to select a feedback network.

circuit is inadequate, however, to compensate large differences in production tolerance of individual optocouplers. Also, in its basic layout, it can not rule out the effects of differently shaped Rf characteristics and device-specific minimum and maximum values of Rf.

The use of the new H11F3 as a semiconductor switching element poses less problems than the previously mentioned applications. The typical junction resistance of Rf is 100 to 300 ohms at a LED current of 30 mA (60 mA max.). With no current passing through the LED, the FE element reaches an off-resistance of no less than 300 mega-ohms at a stray capacitance of about 15 pF. Figures 7a and 7b show the use of Rf as a short-circuiting and a

11

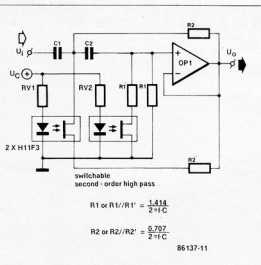

Fig. 11 High-pass filter with a switchable cut-off frequency.

12

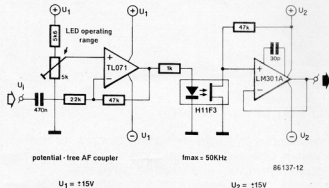

Fig. 12 An electrically safe input amplifier.

series-connected. AF switch, respectively. The attainable signal attenuation is considerably improved with the combined use of a parallel and a series-connected FE element—see Fig. 8. The control currents applied to the LEDs are in anti-phase, and the entire circuit may be doubled to make a balanced attenuator with very good AF characteristics. Fig. 9 shows the basic layout of an **AF input channel selector**, featuring click- and noise-free operation. The distortion caused by the FE junction is acceptable, as there is a voltage drop of only a few millivolts with the FE element turned fully on. A further development of the circuit in Fig. 9 is the **programmable amplifier stage** shown in Fig. 10. Depending

on the levels of VC₁, VC₂ and VC₃, voltage divider RA-RA₁, RA-Ra', or R₀-R₀' provides the bias voltage for the inverting input of the opamp. Feedback resistor R₀ prevents the opamp from being configured for its maximum open-loop gain in the absence of control voltages for the IR LEDs. VC₁, VC₂ should be obtained from a make-before-break rotary switch, or the logic equivalent of it, to prevent the output level of the circuit from varying during the switching over to a different amplification factor. Fig. 11 illustrates the use of the H11F3 in a switchable active filter. This circuit can be dimensioned to function as a click-free rumble or high-frequency noise filter. For relatively low values of the frequency determining resistors, it may be necessary to study the effects of changing the values of RV₁ and RV₂. In conclusion of this miscellany of basic circuits and practical applications, Fig. 12 shows an electrically isolated input amplifier, which is also usable as a safe signal processor for sensors in biological and medical measurements.

EK

Distributors of GE products in the UK:

Distributed Technology:
(08833) 6161 • Farnell Electric Company: (0532) 636311 • STC Electronic Services: (0279) 26777 • Hero Electronic: (0525) 405015.

battery saver

W. Jitschin

With many electronic games, such as heads-or-tails, roulette, or any of the versions of electronic dice, a considerable saving in battery life can be obtained by ensuring that the circuit, or at least the current-guzzling displays, are

switched off after each throw or turn. Naturally enough, it would be somewhat tiresome to have to do this by hand, so the following circuit is intended to take care of this chore automatically.

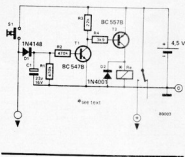

Basically the circuit is a simple timer. Pushbutton switch S1 is the start button for the die, roulette wheel, etc. When depressed, it causes capacitor C1 to charge up rapidly via D1. Transistor T1 is turned on, so that, via T2, the relay is pulled in, thereby providing the circuit of the game with supply voltage.

When the switch is released, initially nothing will happen. C1 discharges via R1, R2 and the base-emitter of T1, however it takes several seconds until it has discharged sufficiently to turn off T1. When it does so, however, the relay drops out, cutting out the power supply to the die, etc.

With the component values shown in the circuit diagram, a delay of roughly 3 seconds is provided in which to read off the display. If that interval is too short (or too long), it can be modified as desired by choosing different values for C1 and/or R1/R2.

MSX EXTENSIONS — 4

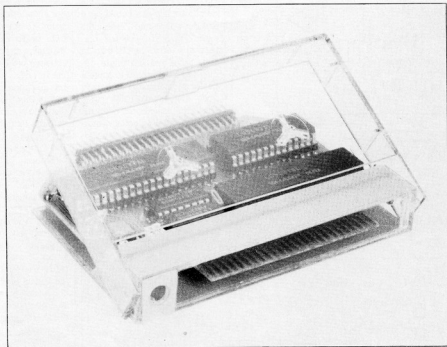

I/O and timer cartridge

Fourth in our series on simple to make extension boards for the MSX series of computers is a versatile, cartridge-size, input/output plus timer module, primarily intended to drive the computerscope featured in our September and October 1986 issues.

This article presents those many owners of an MSX computer with an interface extension board featuring

- 32 (4 times 8) I/O lines;
- 4 programmable timers;
- user-definable address decoding;
- daisy-chained interrupt configuration.

All of these functions have been realized on a single, cartridge-size board which can be housed in a common music cassette box. Although the first aim of this design is to provide an interface between an MSX computer and the computerscope, the I/O and timer cartridge can fulfil a variety of tasks. For instance, there is the field of robotics where stepper motors are to be driven via a computer interface (see *Universal control for stepper motors*, elsewhere in this issue). The present extension board is

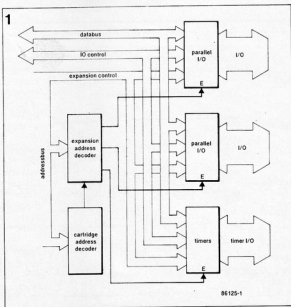

Fig. 1. Block diagram of the MSX I/O and timer cartridge.

also tailored to drive an MSX EPROM programmer, which will be detailed in a forthcoming issue of *Elektor Electronics*. However the present article will mainly focus on how to use the I/O and timer cartridge in conjunction with the computerscope.

The previous instalments of this series were published in the January, February and March 1986 issues of *Elektor Electronics*.

Block diagram

Figure 1 shows the various functional blocks comprised in the I/O and timer cartridge.

The cartridge address decoder defines the I/O channels through which the card is accessed by the Z80 microprocessor. It will be recalled that MSX computers use I/O mapping

based on 255 (2^8-1) channels, rather than reserving a specific address area in the system RAM to transfer I/O data and I/O status/control words. After the processor has selected the cartridge by means of an appropriate I/O instruction, the expansion address decoder is enabled to select either one of two parallel I/O blocks, or the timer block. The expansion control bus provides the peripheral blocks

with information as to the nature of the word then present on the databus, since this is used to bidirectionally transfer both data and status/control words. Each I/O block comprises two sets of 8 I/O lines plus associated peripheral handshaking lines; the cartridge, therefore, has 32 I/O lines in all, i.e. enough and to spare for all sorts of applications. The timer block comprises 4 individually addressable coun-

ter/timer units in a single chip.

The cartridge hardware

With the use of three LSI chips from the Z80 peripheral support family, the circuit diagram of the I/O and timer cartridge, shown in Fig. 2, closely resembles that of the block diagram. Cartridge address decoder ICs

compares a preset 4-bit address with CPU address bits A₄-A₇, and activates its A=B output whenever the two configurations match, i.e. when the computer accesses the cartridge. The previously mentioned 255 I/O channels can be addressed via the least significant byte on the CPU address bus (A₀-A₇), while IORQ indicates a CPU I/O cycle rather than a memory access cycle. In MSX BASIC, input and output instructions are simply **INP (xxx)** and **OUT xxx,n**, respectively, where **xxx** is the I/O channel and **n** is the byte to be output.

Since I/O channels 64 through 255 are reserved for standard MSX software and hardware, A₈ and A₉ in the preset address nibble are hard-wired to ground (logic low) so as to avoid I/O contention problems between the cartridge and resident I/O mapped hardware. Table 1 shows the jumper configurations to define the 16-channel I/O block through which the cartridge is to be accessed.

Address comparator IC₂ need not be strobed with IORQ as the peripheral LSI chips IC₁, IC₂ and IC₃ each have their own IORQ input to this effect. IC₁ is a dual 2-to-4 line decoder which provides the PIOs (Parallel Input/Output) and the CTC (Counter/Timer Controller) with CE (chip enable) pulses. These three peripheral functions are selected by an appropriate bit-configuration of address lines A₂ and A₃, provided, of course, the A=B output of IC₁ is logic high. Note that output 3 of decoder 1 in IC₁ (pin denotation: IQ3) is used to drive the active low E2 (strobe) input of decoder 2; decoder 1, therefore, merely functions to invert the A=B output from IC₁. If selected with CE, the PIOs and the CTC have access to the CPU data bus as IORQ goes low. The direction of the data

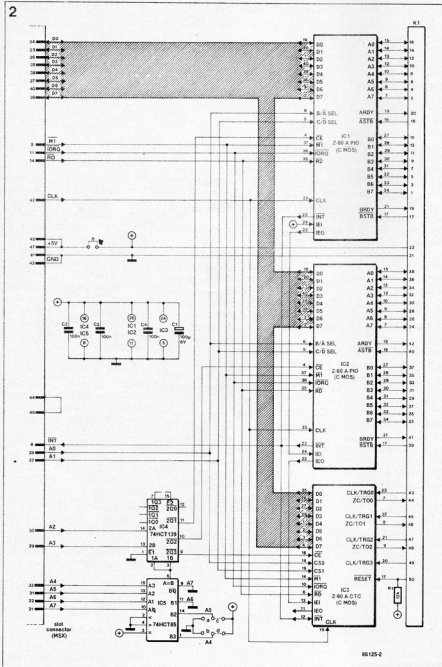

Fig. 2. Circuit diagram of the multi-I/O and timer extension for MSX computers.

cartridge I/O block (decimal)	jumpers
0-15	a b
16-31	a d
32-47	c b
48-63	c d

Table 1. The cartridge address block assignment.

flow—i.e. CPU to peripheral, or vice versa—is determined by the logic state of the RD line. Provision has been made to process PIO or CTC-generated interrupts by connecting the INT outputs of IC₁, IC₂ and IC₃ in a wired-OR structure. The daisy chain connection of the IEI and IEO (interrupt enable input and output, respectively) signals is essentially a method of interrupt priority assignment. In the cartridge, IC₁ has the highest interrupt priority, IC₂ the lowest. Once IC₁ activates its INT output, IC₂ and IC₃ are disabled from outputting interrupt requests to the processor. In this system, high-priority peripherals automatically override INT requests from devices "further down" the daisy chain. Upon receiving an INT pulse, the CPU polls the peripherals to determine the origin of the INT request. This is done by means of an INTACK (interrupt acknowledge; MI AND IORQ) pulse, which causes the relevant peripheral to respond by putting a vector byte onto the databus. This vector is used as the LS address byte for the interrupt service routine. In a Z80-based system, pulses MI and IORQ are used to form the INTACK pulse, while the interrupt vector is loaded into the devices during the initialization routine. PIO IC₁ has been assigned the highest priority on the cartridge since PIO IC₂ and CTC IC₁ are not used in the driving of the computerscope. The chips on the cartridge board are either fed from the computer +5 V supply, or from an external supply connected to pins 21 (GND) and 22 (+5 V) of 50-way output connector K (remove link e). If all chips in the cartridge are of the CMOS type, the supply capacity of the computer should be adequate, and link e can, therefore, be left in place. In theory, the application of standard NMOS chips in the IC₁, IC₂ and IC₃ positions requires the cartridge to be fed from an external supply, as the total (worst case) current demand of the board is then about 320 mA, exceeding the available 300 mA supply capacity of the computer slot. In practice, however, we measured a current demand of about 100 mA with NMOS chips fitted in the circuit, which could, therefore, be fed from the computer without overloading the internal

+5 V supply. From these observations it can be seen that it is good practice to measure the actual current consumption of the cartridge before deciding on computer or external supply.

Programming the PIOs

The Type Z80A PIO from Zilog features two 8-bit ports, which can be set to one of four possible operating modes by writing an appropriate byte to the command register in the chip. The logic state at the B/A SEL input determines which one of the two ports is to be read from or written to (port A or B), while the bit at C/D SEL indicates transfer of a control/status word (C) or a data word (D) via the 8-bit databus. Address lines A₂ and A₁ drive B/A SEL and C/D SEL, respectively, enabling the user to configure each PIO for any one of its four possible modes. MODE 0 selects the port A & B byte output mode, MODE 1 the byte input mode, MODE 2 the byte input/output mode, and MODE 3 the bit-programmable input/output mode. Modes 0 and 1 and 2 operate on the basis of interrupts, and can, therefore, only be used with the Z80 CPU programmed to operate in its interrupt mode 2. This requires running a machine language program to define the address of the interrupt service subroutine. In the case of the MSX computer, however, the VDP-generated interrupts must first be disabled with instruction VDP (1)=VDP(1) AND 223. Following the servicing of the cartridge-generated interrupt, the display interrupts must be enabled again by reprogramming the Z80 for mode 1 interrupt operation and next running command VDP(1)=VDP (1) OR 32. Considering the complexity of the foregoing programming sequence, it was thought useful to further examine PIO MODE 3, which enables ready programming—i.e. in BASIC—of the cartridge without the need to observe the intricacies of interrupt service subroutines. Those MSX users interested in using PIO MODE 0, 1, or 2 should consult Zilog's copiously detailed *Components Data Handbook*, or their *Z80 Applications Hand-*

CTC bit	function		note(s)
	low (0)	high (1)	
D ₀	vector	control byte	
D ₁	—	software reset	
D ₂	no time constant	time constant follows	
D ₃	trigger upon loading time constant	clock/trigger pulse starts timer	timer mode only
D ₄	falling edge	rising edge	CLK/trigger edge select
D ₅	:16 prescaler	:256 prescaler	timer mode only
D ₆	timer mode	counter mode	
D ₇	enable INT	disable INT	

Table 2. Bit functions in the Z80 CTC control register.

book.

The following instruction sequence initializes MODE 3 in the PIO:
 Mode Control Byte = &HFF (define MODE 3);
 I/O Register Control Byte = &Hxx (see example below);
 Interrupt Control Byte = &H07 (interrupts disabled);
 Interrupt Disable Byte = &H03 (may not be required);

The byte written to the I/O register in the PIO determines whether the individual lines are inputs (logic 0) or outputs (logic 1). Example: sending byte &HF0 to the I/O A register sets port lines A₆, A₅, A₂ and A₁ to inputs, while A₄, A₃, A₀ and A₇ are set to output operation. After the initialization routine, data can be output and input via the port lines. Evidently, each of the ports must be initialized as set out above. This is done by selecting the appropriate chip (I/O address lines A₂ and A₁), the appropriate port (A/B), and control/data access, as required. All of this is accomplished by a sequence of write instructions to addresses within the cartridge I/O block.

Programming the CTC

The Type Z80 CTC comprises four individually configurable counter/timer circuits. The function of each bit in the CTC control byte is shown in Table 2. The stated time constant (bit D₂) determines the number of pulses before the ZC/TO output goes high. Each timer/counter will continue to operate until a software (D₁) or a hardware

reset (pin 17) is received by the CTC.

Construction

Since the proposed I/O and timer module is to function as a plug-in cartridge for MSX computers, there can be no doubt about the need for a ready-made, double sided, and through-plated PCB—see Fig. 3. As there are relatively few components on this board, no problems are envisaged if due care is taken to solder accurately; many tracks run quite close to another and are, therefore, in danger of being accidentally shorted by excess solder. There is an important point to note before actually starting to populate the board. Make sure that it fits into the prepared music cassette holder; it may be necessary to do without IC sockets to ensure the absolute minimum height of the board, in order that the cassette box can be closed properly. The reel posts and any other studs in the cassette box must be removed, and a rectangular slot should be cut as shown in Fig. 4. The home-made cartridge must be sufficiently sturdy to be able to withstand being plugged in and removed again quite frequently, without developing contact problems on the connecting copper tracks at the slot side of the board.

MSX software for the computerscope

The general programming

Parts List

Resistor:

R1 = 12K

Capacitors:

C1 = 100µF 6 V

C2, C3, C4 = 100 n

Semiconductors:

IC1, IC2 = 280A PIO *

IC3 = 280A CTC *

IC4 = 74HCT139

IC5 = 74HCT85

*CMOS version is preferred;

see text.

Miscellaneous:

3 off jumper pins for link e

1 off 2 x 3 contacts jumper block

3 off jumpers for above blocks

K1 = 50-way plug for PCB edge mounting (right angle type)

PCB Type 86125

1 music cassette box (see text).

3

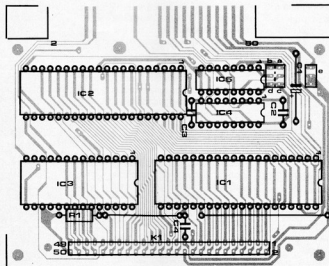

Fig. 3. Component mounting plan for the I/O and timer cartridge.

4

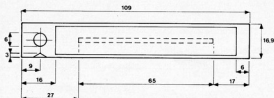

Fig. 4. Dimensions of the rectangular clearance cut into the music cassette box.

methods for operating the computerscope (see *Elektronics*, September and October 1986) in conjunction with an Electron, C64, or BBC computer, also apply to the MSX software supplied with PC board Type 86125. However the limited screen resolution of MSX computers necessitates a slightly different position for the oscilloscope controls texts—see Fig. 5. The various scope "controls" can be selected as required by means of the function keys on the MSX keyboard, while the cursor positioning keys permit setting the requisite parameter value. In view of the previously mentioned limitation imposed on the attainable resolution of the MSX screen (192 x 256 dots), it

was found impossible to retain the quantifying figures alongside the vertical and horizontal axes.

The function keys F1 through F9 on the MSX computer are programmed to do the following: F1 sets the required amplitude and merits no further comment. F2 and F3 serve to set the vertical offset and the trigger level, respectively. This involves the displaying of an absolute voltage level, and, since the trigger level is comprised in the sample byte, changing the vertical offset causes the trigger level to be changed accordingly. The computer displays the trigger threshold thus obtained by a small, blinking, bar. The screen division (graticule) can be defined either in 1-pixel

5

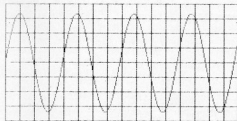

```
f1:ampl: 200mV/div      f6:time: 20µs/div
f2:verof: 400mV        f7:horiz: 150µs
f3:trig1: -400mV       f8:slope: +
f4:trig2: auto         f9:mode: single
f5:input: ac           f0:scrdm:
```

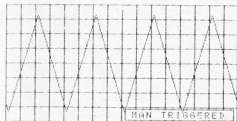

```
f1:ampl: 500mV/div      f6:time: 20µs/div
f2:verof: 250mV        f7:horiz: 150µs
f3:trig1: -1V          f8:slope: 4
f4:trig2: manual       f9:mode: single
f5:input: ac           f0:scrdm:
```

Fig. 5. Two examples of the use of the screendump option offered by the computerscope software.

increments (cursor up/down), or in 8-pixel increments (cursor left/right). This arrangement is also valid for function 7.

F4 selects the trigger mode: automatical, manual, or external. The automatical trigger mode causes the computer to establish the trigger level after depression of the space bar. In the manual and external modes, the computer waits for the spacebar to be pressed a second time, indicating a manual trigger pulse, or a trigger enable pulse (EXT).

F5 selects input mode AC, DC, or GND (0 V).

F6 sets the timebase.

F7 sets the horizontal position of the trigger instant.

F8 selects a positive or a negative trigger slope.

F9 selects the display mode: single (+delete), continuous (+delete), or continuous. Pressing the DEL key causes the display to be erased before showing a new image.

F10 permits outputting the screen page contents to a printer (screendump mode). The initialization routine in the MSX computerscope program is specific to the Smith Corona series of printers; other types may require rewriting the routine to suit the relevant bit image mode and the print head layout. With some skill in machine language programming, writing one's own screendump subroutine is conveniently started by carefully studying the Smith Corona version supplied.

Table 3 shows a straightforward test program to check the performance of the cartridge and the computerscope board, in a similar manner as already detailed for the BBC and Electron computers. The cartridge is connected to the computerscope as shown in Fig. 6. It is seen that the PIO handshaking lines ARDY (port A ready) and ASTB (port A strobe) are not used in the basic set-up. However to improve upon the overall speed of the communication between computer and computerscope board, one of the unused inverters N_{16} - N_{19} on the latter may be connected as shown in Fig. 6 to effect inversion of the READY output of the computerscope board. It must be noted, however, that the MSX software supplied is based on PIO MODE 3, as already detailed, and therefore does not

support the use of the handshaking lines. Experienced programmers may have a go at writing an interrupt servicing routine that does permit the use of ASTB, while ensuring that the MSX screen timing (VDP) remains correct. In all, the writing of a subroutine satisfying the foregoing conditions is rather specialized work, and if you feel not quite sure about it all, simply leave the ASTB line open and the set-up will still be sufficiently fast.

Finally, MSX users interested in further details on machine language programming will find invaluable information in *The MSX red book*, by Avalon Software, and in *Behind the Screens of MSX*, by Mike Shaw. Both books are published by Kuma Computers Limited, Pangbourne; Berkshire. Telephone: (07357) 4335; Telex 849462 TELFAC. These new publications will be reviewed in the *New Literature* columns in a forthcoming issue of *Elektronics*.

The next instalment in this series of articles will deal with a MSX EPROM programmer, which operates in conjunction with the I/O and timer cartridge.

```

10 SCREEN 2
20 A=3*16
30 DA=A+4: DB=A+5: CA=A+6: CB=A+7
40 OUT CA, 255: OUT CA, 0: OUT CA, 7: OUT DA, 6H10
50 OF=0: IN=1: NI=0: TH=0: TB=8: AM=8: TR=0
60 OUT CB, 255: OUT CB, 0: OUT CB, 7
70 OUT DB, (OF+64+128*NI): OUT DA, 6H14
80 OUT DB, (NI+64+128*TH): OUT DA, 6H12
90 OUT DB, (TB+16*AM): OUT DA, 6H11
100 OUT CB, 255: OUT CB, 255: OUT CB, 7: OUT DA, 0: OUT DA,
    6H40: OUT DA, 6H10
110 HO=TIME+(TB+1)*50
120 IF HO>TIME THEN120
130 IF TR=0 THEN OUT DA, 6H30
140 IF TR=1 THEN OUT DA, 6H38
150 IF TR<>2 THEN 160 ELSE IF INKEY9=" " THEN OUT DA,
    6H90 ELSE 140
160 HO=TIME+3*(TB+1)*50
170 OUT DA, 0: OUT DA, 6H20: OUT DA, 0
180 CLS
190 PSET (0,85)
200 FOR I=0 TO 255 STEP 2
210 LINE -(I/2, 150-INP(DB)/2)
220 OUT DA, 6H40: OUT DA, 0
230 OUT DA, 6H40: OUT DA, 0
240 NEXT
250 OUT DA, 6H20
260 FOR I=256 TO 512 STEP 2
270 LINE -(I/2, 150-INP(DB)/2)
280 OUT DA, 6H60: OUT DA, 6H20
290 OUT DA, 6H60: OUT DA, 6H20
300 NEXT
310 GOTO 50

```

AR Table 3. MSX-test computerscope.

6

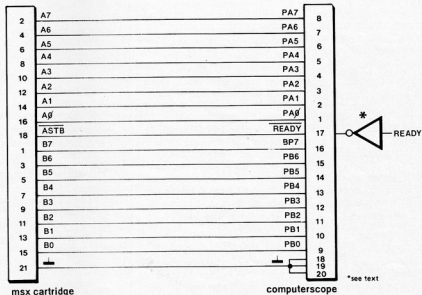

Fig. 6. Overview of connections between the cartridge and the computerscope.

JUNIOR COMPUTER

FACTS

Hot ICs - no need for fear

It is perfectly normal for ICs particularly bipolar digital ICs such as TTL, to become very warm in operation. These ICs draw considerable power which is finally dissipated as heat. An example is the common TTL IC 74145. Typical dissipation for this device is 215 mW and approximately 360mW maximum, this is in the quiescent state with unloaded outputs. When these are loaded the dissipation is even higher. Since the area of the IC package is relatively small, the IC becomes very warm indeed. This is no problem, however; it is rated appropriately and operates perfectly even at ambient temperatures of upto 70°C. When the computer is installed in a housing, care should be taken to provide ventilation slots for the heat to dissipate. In the event of doubt regarding the temperature rise of ICs, the data sheet should be consulted. An IC with a maximum dissipation of 10 mW for instance, should not exhibit noticeable temperature rise.

The Microcomputer as a source of interference

Every microcomputer system operates with relatively fast logic ICs, such as Schottky TTLs. This means that the digital signals have rapid-rise slopes which produce harmonics extending far into the VHF/UHF region. This cause interference, and not only to FM stereo reception. The problem is not restricted to home made microcomputers; some commercially built microcomputers, particularly teaching and experimental system, can unfortunately be classed as sources of electromagnetic pollution. The only solution is to install the microcomputer in a (metal) screened housing with an earth connection; it may also be necessary to fit a mains RF-suppression filter. Scree ned (coaxial) cable should be used for connections between the computer and peripheral equipment. These precautions apply to all digital equipment using fast logic.

the Junior Computer as a frequency counter

G. Sullivan

Microprocessor systems are often regarded as mathematical wizards, so the Junior Computer's aptitude as a frequency counter will come as no surprise . . .

As the name suggests a 'frequency counter' records a recurrent series of events. This does not necessarily have to be anything to do with electronics. The merry month of May, for instance, (and any other month, for that matter) has a frequency of one sunset every 24 hours (although it isn't often seen in the British Isles). To take an electronic example, if an AC voltage changes its polarity one hundred times per second, this is referred to as a frequency of 50 Hz.

The point is, by what criteria is frequency measured? In the second example the number of polarity changes (from positive to negative, or vice versa) that occur during one second are simply counted. When a microprocessor is

'hired' to do the calculation work, a program consecutively displays the contents of three display buffers, in other words the last frequency to be measured. The program is interrupted either once the one second measuring time has passed, or the AC voltage has gone low. A new program is now run to check the cause of the interrupt. If a zero-crossing was involved, the period counter is incremented by one. But if the measuring time (1 second) has passed, the contents of the counter memory locations are copied into the display buffers. At the same time, a new measuring period begins. At the end of the process, a return is made to the main routine, after which the whole procedure starts all over again.

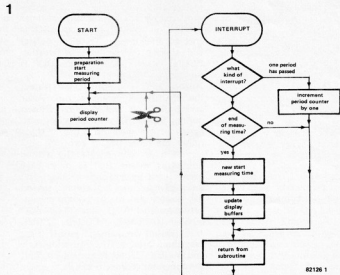

Figure 1. A series of interrupts (IRQ) are required for frequency measurement.

82126 1

```

$1A00 A9 $0 INITR LDIM $00
$1A02 B5 D0 STAZ ACCUL
$1A04 B5 D1 STAZ ACCUM
$1A06 B5 D2 STAZ ACCUH
$1A08 A9 29 LDIM IRQSRV
$1A0A B0 7E 1A STA IRQL
$1A0D A9 1A LDIM IRQSRV/256
$1A0F B0 7F 1A STA IRQH
$1A12 B0 E6 1A STA EDETC
$1A15 A9 10 LDIM $10 (1610)
$1A17 B5 D4 STAZ TINGER
$1A19 B5 D3 STAZ COUNT
$1A1B A9 3D LDIM $3D (6110)
$1A1D B5 D5 STAZ TIMEL
$1A1F B0 FF 1A STA CNTH
$1A22 56 CLI
$1A23 20 8E 1D LOOP JSR SCANDS
$1A26 40 2J 1A J1F LOOP
$1A29 48 IRQSRV PMA
$1A2A 8A TXA
$1A2B 48 PMA
$1A2C 98 TYA
$1A2D 48 PMA
$1A2E 20 D5 1A BIT BFLAG
$1A31 10 10 BFL ADD
$1A33 A5 D5 LDAX TIMEL
$1A35 B0 FF 1A STA CNTH
$1A38 06 D3 DECE COUNT
$1A3A D0 28 BNE EXIT
$1A3C A2 $0 LDIM $00
$1A3E A8 $0 LDYIM $00
$1A40 B5 D0 STORE LDAX ACCUL,X
$1A42 95 F9 STAZ INH,X
$1A44 94 D0 STYX ACCUL,X
$1A46 0A DEX
$1A47 10 F7 BPL STORE
$1A49 A5 D4 LDAX TIMEL
$1A4B B5 D3 STAZ COUNT
$1A4D D0 15 BNE EXIT
$1A4F 08 ADD SED
$1A50 10 CLC
$1A51 A5 D0 LDAX ACCUL
$1A53 69 $1 ADCIM $01
$1A55 B5 D0 STAZ ACCUL
$1A57 A5 D1 LDAX ACCUM
$1A59 69 $0 ADCIM $00
$1A5B B5 D1 STAZ ACCUM
$1A5D A5 D2 LDAX ACCUH
$1A5F 69 $0 ADCIM $00
$1A61 B5 D2 STAZ ACCUH
$1A63 D8 OLD
$1A64 68 EXIT PLA
$1A65 A8 PAX
$1A66 68 PLA
$1A67 AA TAX
$1A68 68 PLA
$1A69 40 RTI

```

ADDITIONAL ZERO PAGE LOCATIONS

```

ACCUL $00D0
ACCUM $00D1
ACCUH $00D2
COUNT $00D3
TIMEL $00D4

```

Table 1. The frequency counter program.

N1,N2 = 1/3 IC1 = 4049

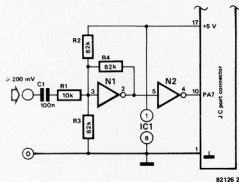

Figure 2. This circuit is added to the Junior Computer to effect the program in figure 1.

The events are depicted in the flow chart in figure 1.

A certain amount of hardware is also needed and this is shown in figure 2. This circuit is connected to the port connector of the Junior Computer to allow the frequency data to be entered into the computer. A significant negative zero-crossing in the input signal will pull port line PA7 low. The program makes sure this is accompanied by an IRQ.

The software is provided in the table. The start address of the program is \$1A00. When data is written into location EDETC, PA7 is pulled low thereby enabling an IRQ. Preparations include defining the IRQ jump vector at the start address of the IRQSRV interrupt routine, starting the interval timer (CNTH, in other words, an IRQ is enabled after every 1024 clock pulses) and storing the contents of location COUNT. Then the program LOOP is run until an IRQ takes place.

As soon as any type of IRQ is detected, the IRQSRV program is run. After saving the A, X and Y contents (used during SCANDS) on the stack, the computer examines the N flag. If N, or rather the timer flag, is zero, the IRQ cannot have been enabled by a time out. This means that it must have been caused by a change in logic level on PA7. A new AC voltage period has passed and so the computer proceeds to label ADD. The 24-bit BCD number (ACCUH, ACCUM, ACCUL — the period counter in figure 1) is incremented by one. After restoring A, X and Y (EXIT) and executing an RTI, the computer returns to LOOP.

Supposing the IRQ was caused by a time out in the interval timer. The timer is started afresh and the contents of COUNT are decremented by one. Provided COUNT has not yet reached

zero, a jump will be made to EXIT. If, however, COUNT is in fact zero, the STORE section is run. The measuring period has now passed and the display buffers, POINTH, POINTL and INH, are assigned values equal to those of ACCUH, ACCUM and ACCUL, respectively.

So much for the program, let's put everything into practice. Connect the circuit in figure 2 to the port connector, enter the program on the keyboard (or even better, read it in from cassette) and start it via the main JC keyboard. (The main JC keyboard must be used, so as to provide the I/O definition for SCANDS.) The highest frequency that can be measured is about 10 kHz. At low frequencies greater accuracy may be obtained by extending the measuring time to 10 seconds (load A0 instead of 10 into TIMEH, address \$1A16). The result on display will of course have to be divided by ten to give the correct frequency.

Literature:

Chapter 6 of the Junior Computer Book II.

For Junior Computer Book & Kit see page 3.64

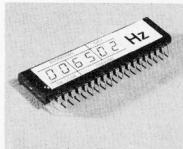

A theory which has been with us for some time and which is rapidly gaining credence relates to the quantity of negative ions in the air. A high concentration of such ions is both physically and mentally healthy. One element of scientific thought actually states that the quantity of negative ions contained in the air around areas such as St. Moritz is high, which is one reason for the invigorating effect these resorts have on tourists. There certainly seems some truth in these suggestions as negative ion generators are gaining in popularity. Even institutions traditionally known for their ultra-conservative attitude towards new ideas are now using them. We published a circuit for a domestic ioniser a couple of years ago operated by the mains supply and the idea came to adapt this circuit for use in the car. The circuit design for a suitable power supply is shown in figure 1. It could be loosely termed as a d.c. to a.c. converter. The 555 timer (IC1) produces

7.5 kV. The output is then connected to a sewing needle or something similar.

As most readers already know the electric field strength around a charged body is greatest where the curvature is also greatest, hence a sharp point. An intense field is therefore present at the tip of the needle with electrons being 'sprayed' onto the air molecules negatively charging them. Each batch of negative ions is repelled by the negative charge of the needle point allowing new air molecules to be processed. The result is a constant flow of ions away from the needle which feels very much like a light draught. This in itself will have a refreshing effect upon the driver and passengers without giving consideration to the metabolic benefits of an increased concentration of negative ions.

Keep in mind that apart from generating negative ions the needle will also pro-

in-car ioniser

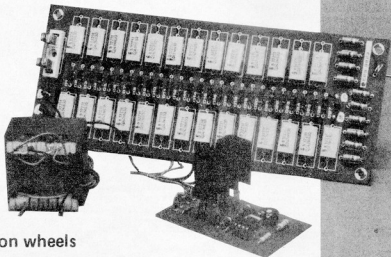

fresh air on wheels

The circuit is one way of increasing the concentration of negative ions in the surrounding air, resulting in improved mental concentration, and reaction speed making roads just that little bit safer. At the very least it will refresh the environment.

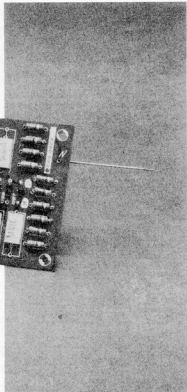

For kits & components contact:

Precious Electronics Corporation
52-C, Proctor Road,
Bombay-400 007
Ph: 367459, 369478
Telex: (011) 76661 ELEK IN

a square-wave signal with a frequency around 85 to 100 Hz. The values of R1 and the combination of P1 and R2 have been chosen so that the square-wave produced is symmetrical. This is then fed to transistors T1, T2 and transformer TR1. The result is an a.c. voltage across the two secondary windings of the transformer of approximately 400 V (square wave).

Figure 2 shows the circuit diagram of the ioniser which consists of a 27 stage voltage multiplier, in order to step up the voltage from 400 V to around

duce ozone (O₃). This can on the one hand have certain advantages as it oxidises organic gasses. Carbon monoxide for instance, can be reconstituted into carbon dioxide which is far less harmful. However, ozone if breathed in large quantities can cause irritation of the respiratory system, because of its corrosive and therefore poisonous nature. We therefore do not recommend using the ioniser near to asthma sufferers and please remember that for normal use the ventilation system of the car should be reasonably effective.

Construction

The printed circuit board for the power supply is shown in figure 3. There is nothing critical in the assembly and the only calibration needed is to set P1 to its mid position. No provision was made for mounting the transformer onto the board as the size and type will depend on what is easily available.

Although it is possible by changing C1 for a 330 nF capacitor to get a 50 Hz a.c. output, we do not advise it. Basically the peak voltage level produced by the circuit using the specified transformer will be far in excess of 240 V, so that 'blowing up' your razor becomes a distinct possibility. The transistors will need small heat sinks. The transformer should have a 220 V primary and two 6 V secondary windings. Its normal function is reversed in this case.

The printed circuit board and component layout for the ioniser are given in figure 4. Great care is needed to mount the components. Make sure all soldered joints are smooth and neat as any protruding wires or spikes of solder could result in unwanted discharges. This is especially important towards the 'high-voltage' end.

Resistors R1 to R10 limit the current flow in the event of the needle being touched. Lowering the value of these or omitting them is inadvisable as it could result in a fatal shock.

Any sharp needle will do as long as its connection to the printed circuit board is short and rigid. Obviously the needle should point outwards and to prevent accidents a short piece of 30 mm plastic pipe should be mounted coaxially with it. After some use the point will become dirty and possibly eroded, so making the needle removable for cleaning is also a good idea.

Safety first is a good motto to follow when mounting the circuit in the car. Use an insulated box to contain the electronics and position the unit within the car so that it is not a hazard to unsuspecting passengers.

Parts list for the power supply

Resistors:

R1 = 1 k
R2 = 47 k
R3, R4 = 470 Ω/½ W
P1 = 47 k preset

Capacitors:

C1 = 150 n
C2 = 10 n
C3, C4 = 560 p

Semiconductors:

T1, T2 = BD 139
D1, D2 = 1N4004
D3, D4 = 27 V/400 mW zener
IC1 = 555

Miscellaneous:

Tr1 = 2 x 6 V/0.8 A transformer
2 heat sinks for the BD 139
S1 = on/off switch

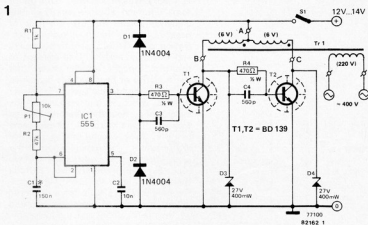
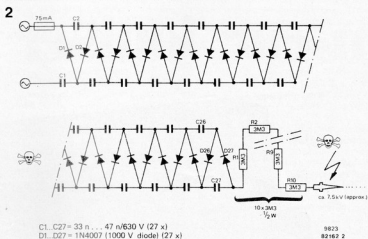

Figure 1. With this circuit the ioniser can be used in the car. With a 12 V d.c. input approximately 400 V a.c. is produced.



C1, C27 = 33 n, ... 47 n/630 V (27 x)
D1, D27 = 1N4007 (1000 V diode) (27 x)

8823
82162 2

Figure 2. The circuit diagram of the ioniser, consisting of 27 diodes and 27 capacitors. The unit is a voltage multiplier delivering 7.5 kV to the probe or needle.

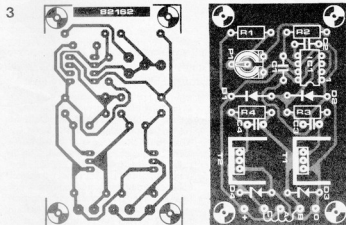

Figure 3. The printed circuit board of the power supply. There is nothing critical in its construction. The transformer uses the 220 V winding as the secondary.

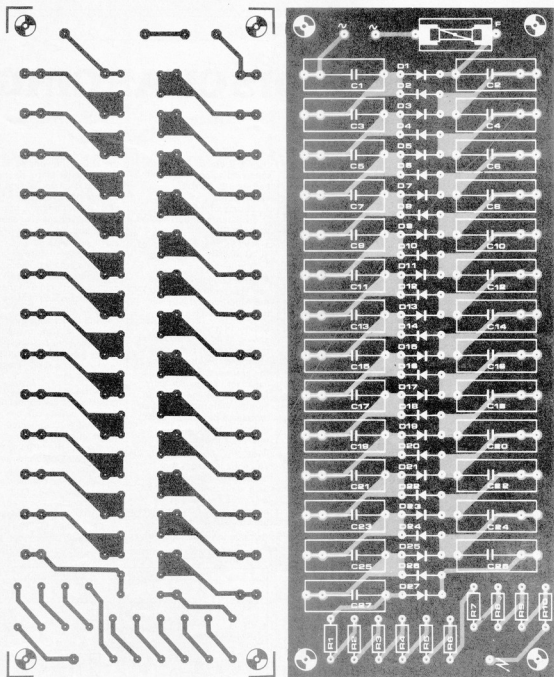

Figure 4. The ioniser board. All the soldered joints and connections have to be smooth and neat in order to eliminate the chances of unwanted discharges.

Parts list for the ioniser

Resistors:
R1 ... R10 = 3M Ω

Capacitors:
C1 ... C27 = 33 n ... 47 n/630 V

Semiconductors:
D1 ... D27 = 1N4007 (1000 V)
F = 75 mA fuses

CHARGING/ DISCHARGING

The capacitor is a device that can hold electrical charge; and when fully charged, the voltage across it is same as the charging battery voltage. Naturally, when the capacitor is fully discharged, the voltage across it is zero volts.

Figure 1 shows the connection of a capacitor directly across a battery. When the capacitor is first connected across the battery, it behaves like a short circuit and a very large current rushes from the battery to the capacitor. As the charge accumulates on the capacitor, the voltage across it rises quickly to the battery voltage and the current flow stops. All this happens very fast because there is no resistance in the circuit. If we introduce a resistance in the current path, the initial high current will be limited by the value of resistance. This will slow down the charging process.

We can observe this process experimentally using the circuits shown in

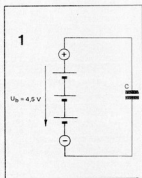

Figure 1: The uncharged capacitor has 0V on it and behaves initially as a short circuit.

Figure 2: Capacitor C is charged by the battery through the resistance R, which limits the initially high charging current. The charging current falls to zero in the end.

Figure 3: When the RC combination is short circuited, the discharging current flows in reverse direction.

figures 2 and 3. The following components will be required for the experiment:

- 1. Battery of 4.5 V
- 1. Resistance of 330 Ω /1/2W
- 2. Red LEDs
- 1. Electrolytic Capacitor of 1000 μ F/10V
- 1. Multimeter.

A small change over switch can also be used to make the experiment a bit easier but it is not essential.

Connect the circuit as shown in figure 2 except for the connection between the LEDs and the plus pole of the battery. Observe the capacitor polarity correctly. The LEDs are connected in parallel with their polarities in reverse directions. Each of the LEDs will thus indicate current in one direction.

The voltage across the capacitor is initially at 0V as it is discharged. Now make the connection between the LEDs and the plus pole of the battery. Observe the multimeter and

the LEDs. The voltage on the capacitor starts rising and LED1 glows. At first the voltage rises very fast and LED1 glows brightly, but soon the voltage rise slows down and glow of the LED starts decaying. This indicates the nature of charging process. The multimeter shows the capacitor voltage and the brightness of LED shows the intensity of current flowing to the capacitor. The capacitor voltage finally reaches about 3 V and not 4.5 as expected. This is due to the voltage drop across the LED.

After the charging process is complete; the connection to the plus pole can be removed and connected to the minus pole, thus connecting the LEDs to the minus pole of the charged capacitor. This time the voltage across the capacitor starts falling and LED2 glows. The voltage drops to about 1V. This, once again, is due to the LED. The discharging current can't

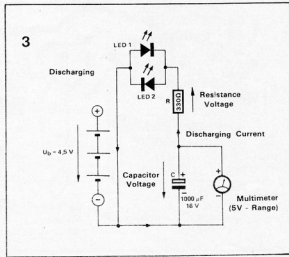
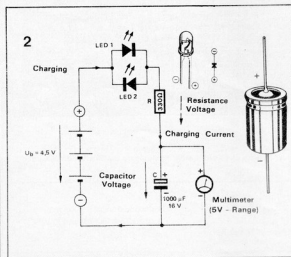

4

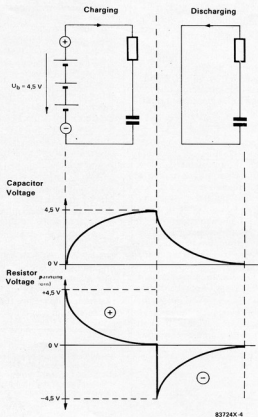

5

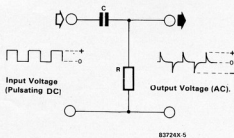

flow through the circuit any more below this voltage.

The charging and discharging cycles can be repeated as often as wanted, to observe the nature of voltage across the capacitor and current through the LEDs.

The current behaves exactly in reverse order compared to the voltage, during the charging cycle. The trend is same even during the discharging cycle - except for the fact that the direction of current is reversed.

This behaviour can be easily explained using the Ohm's law. The voltage across the resistance is always proportional to the current flowing through it. Also the fact that the resistance and capacitor are connected in series (ignoring the LED for convenience) across the battery means that the sum of voltages across the capacitor and resistance must remain constant. Initially during the charging cycle, the capacitor voltage is 0V and the full battery voltage appears across the resistance and thus the current flowing through the circuit is equal to the battery voltage divided by the resistance value. As the capacitor gets charged, the voltage across it builds up and voltage across the resistance falls by the same value. With reduced voltage on resistance, the current also falls. When the capacitor is fully charged the current drops to zero and the voltage across the resistance also becomes zero.

During the discharging cycle, the capacitor supplies the current through the resistance. So the discharging current is equal to the capacitor voltage divided by the resistance value. As the charge on the capacitor is depleted, voltage falls and the current through resistance also falls. However, this time the direction of current through the resistance is opposite to that during charging and we can say that a negative

current flows during discharging and becomes zero again after the capacitor is fully discharged. Let us summarise the observations again:

- When the battery is connected across the RC circuit, the capacitor voltage rises continuously. The voltage across the resistance and current through it are initially high and fall continuously.
- If the RC circuit is disconnected from the battery and short circuited, the current flows in reverse direction. It is high initially and then falls continuously to zero. The capacitor voltage also drops continuously and reaches zero in the end.

Figure 4 shows the schematic circuit diagrams and the curves of capacitor and resistor voltages. These waveforms show an interesting feature of the RC circuit. The capacitor voltage is a pulsating DC voltage where as the resistance voltage is an AC voltage. This type of RC combination can be used to obtain an AC voltage from a pulsating DC voltage as shown in figure 5.

Figure 4: While charging, the sum of voltages on R and C is 4.5 V. While discharging the sum of voltages on R and C is 0V. The waveform of current through the resistance is same as that of the resistance voltage.

Figure 5: The RC combination filters an AC voltage from the pulsating DC voltage at input.

PHASE SHIFT

The RC-Circuit is one of the most used basic circuit in electronics. In the previous article

'Charging/Discharging we have already seen the effect of giving a pulsating DC voltage at the input of an RC circuit as shown in figure 5 of that article. A similar circuit is also shown in figure 1 here however, this time the circuit is also shown connected to an AC square wave as well as the DC pulsating voltage. A close look at the output waveforms will show that the Resistance voltage is same in both cases, whereas the capacitor voltage in the second part of the figure is an AC waveform.

The AC squarewave voltage can be practically generated by using an astable multivibrator circuit. The AMV circuit is shown in figure 2. The two transistors become alternately conductive. This can be seen from the LEDs in the collector circuits of each transistor. The LED in the collector circuit of a conductive transistor glows brightly. Both the LEDs (LED1 and LED2) glow alternately, showing that transistors T1 and T2 are conductive alternately. Consequently, terminal A is more positive than terminal B for some time and then terminal B becomes more positive than A for some time. This effectively gives an AC square wave between terminals A and B.

The component requirement for this circuit is non critical, and if no error is done during assembly, it will function at the first attempt. The frequency of the square wave is about 1 Hz. Thus the LEDs will alternately glow once every second. The component layout is shown in figure 3. The RC circuit can be connected to the AMV by connecting the links A and

B. The RC circuit is made of a resistance of 100Ω and a capacitor of 1000 μF/16V.

LED3 and LED4 are used to indicate the nature of capacitor voltage. When terminal A is positive, LED1 and LED3 illuminate. LED1, because T1 is conductive and LED3, because the capacitor voltage is positive.

However, LED3 becomes bright somewhat later than LED1, because the capacitor takes some time to charge to the full voltage. When terminal B becomes more positive than A, LED2 and LED4 illuminate. In this case LED4 becomes bright later than LED2, because of the time taken by the

capacitor for charging in the reverse direction. At this stage the capacitor polarity is incorrect, but the capacitor can withstand the voltage reversal as the voltage is small.

If we make a chart of AC Voltages from our observation of the LEDs as shown in figure 4, we can see that the AC voltage on the capacitor is delayed in comparison with that at the input of the circuit. This is called PHASE SHIFT. In actual practice, LED1 and LED2 are never extinguished completely because of the capacitor charging current.

Figure 5 shows the phase shift in case of a sinusoidal AC voltage applied to the RC circuit. The larger waveform is the original input voltage. The smaller waveform is the capacitor voltage. It is not only delayed but has reduced amplitude, because a portion of the input voltage must appear across the resistance also. Here the phase shift is about 60

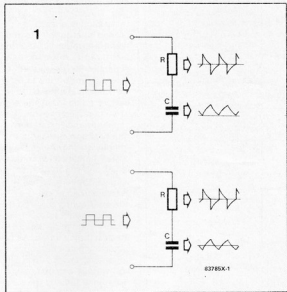
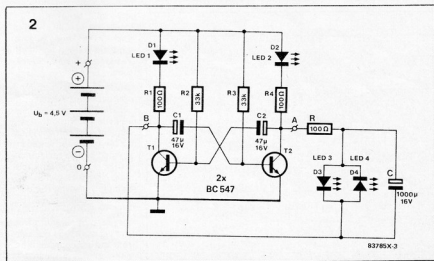

Figure 1: A pulsating DC voltage applied to an RC circuit produces a DC voltage on the capacitor whereas an AC voltage at the input produces an AC voltage on the capacitor.

Figure 2: The Astable Multi-Vibrator circuit produces an AC square wave at terminals A and B.



micro seconds. The phase shift is clearly visible at the point of zero crossing of the waveform.

The phase shift is specified in degrees, considering a full cycle to be made up of 360 degrees, so that the specified value of phase shift becomes independent of the actual cycle time of the waveform. In the example of figure 5, the cycle time is 390 micro seconds, so the phase shift

$$\frac{60}{390} = 360^\circ = 55^\circ$$

In case of low frequency AC voltages, the phase shift is less significant than in case of a high frequency AC voltage. The maximum phase shift that can take place in an RC circuit is 90° . The voltage developed across a capacitor at high frequency is much lower than that developed at lower frequencies because at higher frequencies the capacitor allows more AC current to pass through. It acts like a frequency dependent resistance which reduces with increasing frequency.

Another important feature of a capacitor is displayed in figure 7 which shows the voltage and current waveforms for the capacitor. Voltage waveform is directly taken across the capacitor, whereas the current waveform is taken across the resistance in the circuit of figure 6. The current waveform can be seen to be shifted by 90° compared to the voltage waveform. (One fourth the wave length).

The current through a capacitor always precedes by 90° compared to the voltage across it, independent of the frequency of the applied voltage.

Summary

- The RC circuit causes a phase shift between input and output voltages.
- The phase shift is stated with reference to the wavelength, considering the wavelength to be equal to 360° .
- The phase shift of output voltage of an RC circuit with respect to input voltage is frequency dependent.

The amplitude of output Voltage is frequency dependent

— The capacitor behaves like a frequency dependent resistor.

— The current and voltage on a capacitor always have a phase shift of 90° .

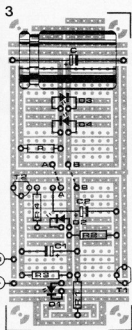

Figure 3:
Component layout for the construction of the Astable Multi Vibrator circuit and the experimental RC circuit on a small SELEX PCB.

Figure 4:
Schematic chart of the illumination of the four LEDs in our experimental circuit. LED 3 and LED 4 glow with a delay compared to LED 1 and LED 2.

Figure 5:
At the zero crossing points of the waveforms we can observe how capacitor voltage is delayed compared to the input voltage. This is the phase shift.

Figure 6:
A sinusoidal AC Voltage applied to RC circuit.

Figure 7:
Phase shift between the voltage and current on a capacitor is always 90° . When one is zero, the other is at the peak value, because 90° is one fourth the wavelength.

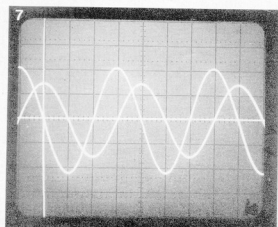
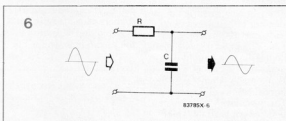
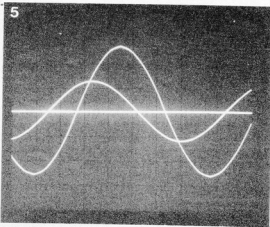
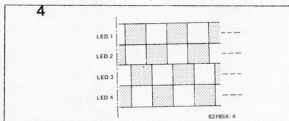

SIMPLE DIMMER

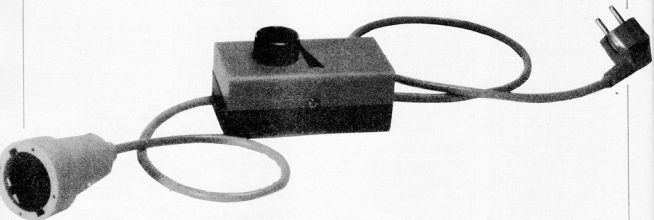

As we have already seen in our Jan. issue, a dimmer is quite a simple device and works on the principle of phase control. One can buy a dimmer from the market and fit it easily on the switch board.

You can also construct a dimmer at home, but don't expect to get the components at a lower cost compared to a bought out dimmer. The cost of your home made dimmer will be almost same - if not more! The size of our home made dimmer will also be larger compared to the dimmers available in the market.

There is no reason to get depressed. Our dimmer can do more than the standard dimmer. It can also be used as a drill speed controller. The noise filter used in our circuit is also better. You may not always find a ripple filter choke in commercial dimmers.

The Circuit

The circuit of the dimmer is shown in figure 1. It has two most important components - a Triac and a Diac. The RC combination is a bit complex and the theory

will not be discussed in detail at this stage. The RC combination shown in the circuit consists of R1, R3, P1, P2 and C1. R1 prevents the rapid charging of the capacitor. This eliminates the possibility of the Triac getting triggered too early. A short pause between the blocking and triggering in the next half wave for the

Triac is essential. Besides this, P1 is protected against large currents. Function of P1 is to decide how rapidly capacitor C1 is charged.

It is possible that due to the large tolerances generally expected on the commercial quality of components, the circuit may not produce proper triggering just by

using the combination of R1 and P1. This is the reason for connecting R3 and P2 in parallel with R1 and P1. The adjustment is achieved by this complex combination for proper functioning of the circuit, the procedure is later described in paragraph entitled "Adjustments".

The series RC combination of R2 and C2 fulfills many functions. The first of all is the protective function. The Thyristors and Triacs are sensitive to excess voltages and voltage spikes. Such type of situations may arise inside the circuit itself or may come from outside on the mains line. Special care must be taken in case of inductive loads like motors, being operated through the dimmer circuit. The series combination of R2 and C2 suppresses these disturbances and protects the Triac from any damage. Another function of the R2 C2 combination is in connection with the ripple filter choke L1. The phase control action and the triggering during every half cycle produces a high frequency disturbance on the power line and can produce noise in audio

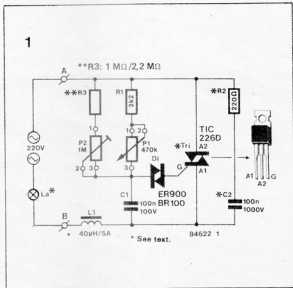

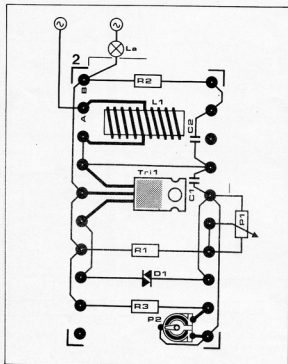

equipment. The filter choke L1 in connection with R2 and C2 tends to suppress such type of noise from being passed on to the power line. R2 & C2 must be properly selected for this purpose.

The circuit of figure 1 has been designed to function as a dimmer circuit. If a drilling machine is to be connected, R2 must be reduced and C2 increased, depending upon the individual characteristics of the drill machine being used. To conduct the trials, a radio set can be switched in the same room. A station

should be tuned, which is a weak station and requires volume control to be kept in a high position.

Now, connect the drilling machine to the circuit and switch it on. Modify the RPM over the entire control range. If a disturbance is heard on the radio, try a combination of 100Ω and 220nF for R2 and C2. Try the following combinations also - 68Ω , 150nF and 150Ω with 330nF . Remember to switch off the mains supply when changing the components. The Triac rating will also depend on the rated power

of the drill machine, and the Triac should be properly selected with adequate safety factor.

Construction

The entire circuit can be constructed on a standard Lug strip. A schematic construction layout is shown in figure 2. A standard SELEX PCB can not be used for this, because of its tracks being very close to each other.

P1 should be a potentiometer with plastic spindle.

If the dimmer circuit is to be used with a lamp, (upto about 200W) then it can be enclosed in a plastic box as shown in the photograph. Internal details are shown in figure 3. A three pin plug and a three core flexible wire should be used for safety reasons. If higher wattage applications are expected, the Triac should be suitably selected and the enclosure for the circuit must have ventilation holes or slits. Heatsink should be used for cooling of Triac.

As the mains voltage is directly involved in this case, proper insulation must be provided.

Adjustments

Please always remember to switch off the mains supply before doing any work directly on the circuit.

For correct adjustment of the potentiometers P1 and P2, follow the procedure outlined below:

Connect a suitable lamp in the circuit. Rotate P1 in its position 3 and P2 in its position 1. The lamp must glow with maximum brightness. Now bring P1 approximately in its centre position. The lamp must become quite dim. Rotate P1 fully to its position 1 and see if the lamp almost extinguishes. If the lamp still glows brightly, rotate P2 towards position 3 and see the effect. If there is no effect, replace R3 by $2.2\text{M}\Omega$ instead of $1\text{M}\Omega$ and begin the adjustment from the start all over again.

If you are using this circuit with a drill machine, the adjustment procedure will be same, only the words "Bright" and "Dark" will be replaced by "Fast" and "Slow" for the drill speed. With P1 in position 3, the motor should stop.

Part List

- R1 = $2.2\text{K}\Omega$
- R2 = 220Ω
- R3 = $1\text{M}\Omega$ or $2.2\text{M}\Omega$
- P1 = $470\text{K}\Omega$ Linear Potentiometer with plastic spindle.
- P2 = $1\text{M}\Omega$ Trimpot
- C1 = $100\text{nF}/1000\text{V}$
- C2 = $100\text{nF}/1000\text{V}$
- Di = ER 900 or BR 100 or equivalent
- Tri = TIC 226 or equivalent
- L1 = $40\mu\text{H}/5\text{A}$ Filter Choke.

Other Parts

- Lug Strip,
- Suitable casing.
- 3 Pin Plug
- 3 Pin Socket/adaptor
- Mains cable with 3 cores.

3

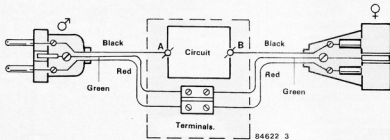

Figure 1: The circuit of the Dimmer

Figure 2: Prototype layout of lugstrip construction.

Figure 3: Internal details for a practical arrangement.

HALF WATTAGE DIMMER

A low cost dimmer can be easily constructed using just a diode if reducing the power to half in one step is acceptable. Compared to the commercially available dimmers with continuously variable output, this dimmer costs almost nothing and can be constructed in a few minutes!

Figure 1 shows the effect of our diode dimmer. The mains voltage is rectified by the diode and the output is just a series of half waves in the positive direction, the negative half being blocked by the diode. Effective voltage is thus reduced to half. Another effect of the diode dimmer is that if a light bulb is connected to it, it shows slight flickering due to the negative half waves being blocked by the diode. The lamp does not receive any current during this period and due to this the light output reduces. This effect becomes less visible when the filament becomes sufficiently hot.

Figure 2 shows the connection of a lamp through the diode. Such a connection also increases the life of the lamp, and is suitable for lamp used in staircases and passages. In addition to saving in cost of replacement of such lamps, it saves us the trouble of replacing these lamps which are generally at some inaccessible positions.

Using two switches as shown in figure 3, one can have a choice between half and full power. The diode can be easily accommodated in the switch housing.

Figure 4 shows a typical connection, which can vary with actual types of switches available.

Before making any changes in the electrical wiring, you must switch off the mains and confirm that no live terminal can give you a shock, using a mains voltage tester.

While selecting the diodes it should be always remembered that the incandescent lamps draw high current at the time of switching on. Diode types 1N4004 to 1N4007 are suitable for lamps upto 100W.

Such type of a diode dimmer is also useful for preventing overheating of soldering irons. Most low priced soldering irons get overheated when they are left unused for some time during soldering work. This causes the flux to completely vaporise and then gives rise to defective solder joints. A simple arrangement using a diode and a microswitch can prevent this. One such possible arrangement is shown in figure 5.

Whenever the soldering iron is kept on the hook, the lever is pulled down, releasing the micro switch and brings the diode into circuit. When the soldering iron is lifted off the hook, the micro switch closes and the diode is bypassed, thus providing full power to the iron when in use.

Two important things must be kept in mind while trying out the diode dimmer described here.

First and most important is that mains voltage must be completely switched off from the Electrical Mains Switch or the Mains Fuse must be taken out before doing any rewiring of switches to include the diode in the

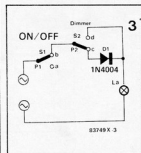
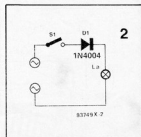
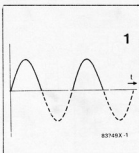

circuit. Not doing so may result in a fatal accident. You must ensure that all the lines are free from mains voltage, before doing anything with the electrical switches and wiring.

Second thing to remember is that the diode dimmer will work only with resistive loads like incandescent lamps, soldering irons, heaters etc. and not with inductive loads like fans.

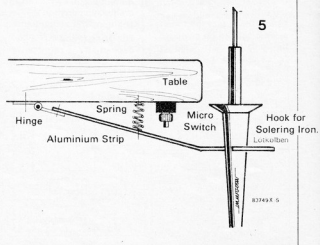
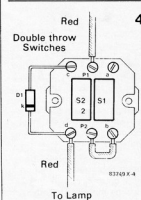

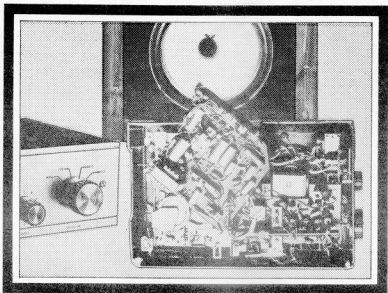

Make your HIFI sing better.

Bipolar/nonpolar Capacitors from ELCOT for double edged advantage.

When your product, a HIFI audio equipment, seeks out a golden note from the groove, a lot of things have to work in perfect harmony. The beautiful circuitry you conceive, must be made with quality components. Any compromise tells on the output.

The range of Bipolar/Nonpolar Capacitors from ELCOT are unmatched in performance. They are being used in quality

HIFI circuits and also where the polarity of the signal is not known. You are getting them upto 50 V and with a range of 0.47 MFD to 47 MFD. Other voltage and MFD, if required, can also be manufactured. Select one of them, make the HIFI equipment made by you sing better.

Go in for ELCOT components. For dependability, reliability and on-the-dot delivery.

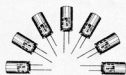

ELCOT

Quality Components from ELCOT
Any other component will be a compromise

Electronics Corporation of Tamil Nadu Ltd.,
(A Govt. of Tamil Nadu Enterprise)

LLA Buildings, 735, Anna Salai, Madras 600 002 Phone: 89642/88005. Telex: 041-6113 LCOT IN

DIPR/547/MS/86/ASP

Branch Offices : 2/20 A.Jangpura-A, Hospital Road, NEW DELHI 110 014. Tel: 694076 (P.P.) Room No.3, 22, Sunil Shopping Centre, Opp. Navrang Theatre, J.P. Road, Andheri (W), Bombay-58. Tel: 622042. 149/A, Mottal Nehru Road, Calcutta-29. 4-3-738, Ramkote, Hyderabad-1. Tel: 552980; Triveni, 35/518, Warnam Road, Cochin-16.

Authorised Dealers : NEW DELHI : Deepjyothi Enterprises (Tel: 5412072), Rabyle Micro Devices (Tel: 734663, 6436990), Orvil Electronics (Tel: 5727407, 5721559, 5728072) BOMBAY : Mehtronics (Tel: 387353), Sahajansand Impex Pvt. Ltd. (Tel: 4136327), PUNE : Esteem Infrastructure (Tel: 64037, 636811), AHMEDABAD : Shreeji Electronics (Tel: 397171, 399435), CALCUTTA : M.A. Shah (Tel: 279699, 266186), BARODA : Maxwell Services Corp. (Tel: 43643), BANGALORE : Linear Systems Inc. (Tel: 351575), Maudgal Marketing Company (Tel: 227411), HYDERABAD : Marvel Electronics (Tel: 62262), Telivrama Enterprises (Tel: 551379), SECUNDERABAD : Cosmos & Electronics (Tel: 822419, 825577), TRIVANDRUM : Bhuvanesh Sales corporation (Tel: 61719), Electronic Equipment & Components (Tel: 77748), NAGPUR : Rematronix, 191/1, Rachna Apartments, Cement Road, Shivaji Nagar, NAGPUR - 10.

TACHOGENERATOR

Advani-Oerlikon have added a new Tachogenerator, Model DTG-P-143-0 to their range of power control equipment. This version gives minimum deviation from the linearity. Minimum ripple in the output voltage, close tolerance regulation and better performance at lower speeds. It is tailor-made to suit operation conditions in various industrial applications. It is Designed for speed indication and feedback control of DC variable speed drives.

The equipment can be flange and/or foot mounted. Special temperature compensation for output voltage can be provided upto 90°C. Also voltage-to speed ratio can be adjusted as per customers requirements.

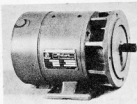

For more details, quote ref. No. P19/7/84 and write to:
Advani—Oerlikon Limited
Post Box No. 1546
Bombay 400 001.

CUTTER - STRIPPER

CYCL-O Has Developed a new cutter-cum-stripper for Electrical cables up to 5 mm in diameter. The stripper strips off wire up to 25 mm/1 inch in Length.



For Further details contact.
CYCL-O COMPUTERS
625 'Panchratna'
Opera House
Bombay 400 004.

FLOWMETERS

Panometrics has introduced a flare gas flowmeter which transmits simultaneously three 4-20 mA outputs: flow velocity V, molecular weight Mw and mass flow rate M. These outputs help flare operators find leaks fast, avoid wasting steam, protect vapour recovery compressor turbines against overheating when vapour molecular weights fall too low, and in general improve material balances and conserve energy and money.



For more informations contact
CHEMTROLS ENGINEERING
PRIVATE LIMITED
910 Tulsiani Chambers
212 Nariman Point
Bombay 400 021.

ABL CAPACITORS

ABL manufacture a wide range of Polyester, Metallised Polyester and Polypropylene Capacitors to suit various small signal circuit applications.

These Capacitors are manufacture with Plant and Machinery from Japan in association with Hitachi.

The Capacitors are available in 2.5mm, 5mm, 10mm, pitches. The Automatic Winding machines, Testing Equipments etc. ensure that the capacitors are of uniform quality.

The following range is currently available.

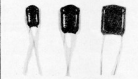

Plain Polyester : .001 uf to 0.68

Plain Polyester Capacitance range :
.001 uf to 0.68 uf
Voltage :
100 V to 630 V
Tolerance :
+ 5% & + 10%

Metallised Poly Capacitors :
Capacitance Range Capacitance :
0.1 uf to 3.5 uf
Voltage Range :
100 V D.C. to 630 V D.C.
Tolerance :
+ 5% & + 10%

For further details please contact:
ABL CAPACITORS (INDIA)
LIMITED.
78, East Avenue Road,
Punjabi Bagh,
New Delhi 110 026.
Telephone : 502068.

HOBBY KIT

EICKIT-511 is for the electronics hobbyist. It includes a loudspeaker, a solderless breadboard, terminals and a mains operated regulated power supply with full protection against accidental short-circuits and overload. A hobby circuits manual, connecting components required for making the projects mentioned therein are included with the kit. No soldering is required and the components can be used over again.

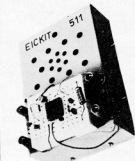

For further details, contact:
ELECTRONIC
INSTRUMENTATION &
CONTROL
24, Visveswaraya Industrial
Area II
Mahadevapura
Bangalore-560 048.

CONNECTOR STRIP

RL Components have developed new type of connectors suitable for direct mounting on PCB/Instruments and transformers. These are available in 2/3/6/8 ways in ratings of 5, 10, 15 A in 130L, 130LS types. Some of the important features of these connectors include-built in terminal marketing arrangement, SHROUDING for protection against accidental touch, same dimensions, clamping action for outward connections, flame-retardant and high impact properties.

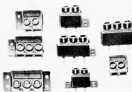

For more details, please contact
M/S. RL COMPONENTS
Yakash Nagari
A-21, Kothrud
Pune-411 029

AUTO SCANNER

ARUN has introduced a Digital Auto Temperature Scanner. The Channel switching is based on CMOS technology instead of conventional Reed switched. The scanning rate can be selected from 1 second to 15 seconds per channel. The Hold mode facility helps to freeze any particular channel reading. The Auto Temperature Scanner is available for all standard industrial thermocouples.



For further details :
M/s. ARUN ELECTRONICS
PRIVATE LIMITED
B-125/126 Ansa Industrial
Estate, Saki Naka,
Saki Vihar Road,
Bombay 400 072.
Phones: 583354/581524

MULTIFUNCTION TIMER

The Model MQT 86 is a battery operated, hand-held timer and also an alarm timepiece. It features a low power C-MOS LSI chip, 6 digit LCD display and quartz control for precision timing.

The count-down timer is adjustable upto 11 hours and 59 minutes. A buzzer beeps for 10 seconds at the end of countdown. The countdown can be 'held' or resumed by pressing the start/stop switch.

A chronograph function is also available in the MQT86 for 'measuring time intervals upto 12 hours. A 'Lap' switch is provided to freeze the reading at any moment, without stopping the measurement.

Time is displayed in 12 or 24 hour format, with indication of day of the week. Further, choice of seconds or date display is also available. The alarm sounds once a day for 30 seconds, or can be kept OFF all the time. Snooze function enables repetition of the alarm at 5 minutes interval, upto 3 times.



For further information, contact:

M/S ION ELECTRICALS
Unique House 5th Floor
25 S.A. Brechi Road
Bombay-400 001

Phone: 286 3386, 286 3426

P.C.B. MOUNTING TERMINAL

OM LILA'S introduces new PCB mounted Screw Terminal Block (Male & Female type). The Range is 2,4,5,6,7,8,10,14,16, & 20 way in different types (1) Straight (2) Right Angle 90° (3) Angular 45° (4) Double

Decker. The Pin dia is 1mm with 5mm pitch. The maximum wire size 2.5 sq. mm can be used.

Current Rating is 5 Amp. at 250 Volts.

Maximum operating temp. 120°. Contact Resistance :- Less than 10 Milliohms.

The Contacts and Pins are Silver Plated.

For further details contact :

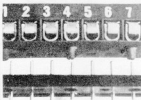

For further details contact :

OM LILA'S
84-A/B, Govt. Ind. Estate,
Kandivli (W) Bombay-400 067
(India)

Tel: 683277, 681097

RADIO COMMUNICATION TEST SET

Hindustan Instruments are marketing an universal communication test set STABLOCK 4039 of M/s. Schlumberger Messgerate, W. Germany, useful for service/control of transceivers in the frequency range of 0.4 to 960 MHz.

The set measures receiver sensitivity, IF bandwidth, centre frequency, squelch, adjacent channel power & harmonics for a quick check of the unit under test. The front panel is divided into functional units each having a different colour for ease of operation. Measured values are displayed by LEDs and also on meters while the call tester can encode & decode various standards ZVETI, ZVEIZ, CCIR, VDEW & NATEL.

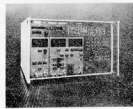

Suitable for field service, the set has a cassette recorder for storing the test results, the hard copy of which can be had through a standard IEE Interface.

For Further Information, please write to :

M/S HINDUSTAN INSTRUMENTS LTD.
603, Vishal Bhavan,
95, Nehru Place,
New Delhi-110 019.

DIGITAL KIT DTKU-16

Alfa Products have developed an Universal Digital Troubleshooting kit DTKU-16 for field/laboratory testing of digital electronic equipment.

The kit has 2 IC based power supplies of 5V & 12V for TTL AND CMOS respectively, an IC tester, logic monitor, pulse generator, frequency indication and indication for '0' and '1' levels.

The DTKU-16 is compatible with most logic IC families and comes with accessories like plug & jack cords, test leads, socket adaptors, etc.



For Further information, please contact :

M/S ALFA PRODUCTS COMPANY
FF-11, Bajaj House,
97, Nehru Place, P.O. Box 4324
New Delhi-110 019.

HANDS FREE PHONE

Sai Enterprises has introduced the 'Technica' Model MR-10 telephone instrument Call can be made or received without lifting the receiver off the hook. The unit has 9 memories and last number redial facility. A built in timer alerts the caller at the end of the preset duration. The unit also has an auto redialling facility for 'busy phones' and dials a particular number upto 15 times.



For further details, contact:

M/S SA I ENTERPRISES
11, Trinwala Building
Tribhuvan Road
Bombay-400 007
Phone: 354166

AIR-CORE CHOKE

Electro Service (India) offers Mu-Netic range of Air-Core Chokes up to 5 Henry-Ampere². Though an air-core choke occupies more space than the conventional iron-core choke it offers a definite linear result and eliminates the risk of core saturation entirely, under appropriate installation and service condition.

Mu-Netic range of air-core chokes are designed and manufactured to meet the relevant IS- specification with regard to insulation resistance, voltage proof and temperature rise.

All Mu-Netic range of air core chokes are specially designed to offer excellent thermal stability, good voltage regulation and very high withstanding ability to transients, over voltage and over current. And they are encapsulated in epoxy resin to ensure minimum deviation from the specified result.

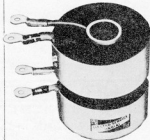

For further details, please contact:

M/S ELECTRO SERVICE (INDIA)
232, Russ Road South,
First Lane,
Calcutta-700 033.

SWITCHBOARD

WANTED - ZX Spectrum+ against Cash. With or without Joystick & Joystick interface Mr. Vivek 1510-D, 2nd Street, Naray Nagar, New Delhi-110 003.

WANTED - IC SP 0256A12. Speech Synthesiser for home computers also interested in exchange of ideas with spectrum owners. Mr. A.S. Bhaskar Raj, carriage and wagon, inspector rail Nilayam C.M.E.'s Office, secunderabad - 500 371.

WANTED - Names of Books on Electronic Design Theory & Technology for Engg. studies in easy language for third year. Mr. Tahas P. Trivedi, 16, Yashwant-Hostel, University Campus, Aurangabad - 431 004.

FOR SALE - Simpson (USA) Digital Multimeter with LED display. Supplied with excellent probes and main cord. SEND OFFERS: Mr. Manik H. Naik, 1, Sadhana Plot No. 217, 27th Road, Bandra Bombay - 500 050.

FOR SALE - Solid State 5" Oscilloscope in good condition fair price. Mr. D.N. Ganguli, 9, Haladpara Road, Calcutta - 700 026.

WANTED - Books on cordless remote control projects and information to get the components for those projects. Mr. Bipin Kumar Serene, 16/544, Wadia Estate Bail Bazar, Kurla, Bombay - 121 002.

WANTED - Service manual/xerox copy for Sharp VCR VC-381 and circuit diagram of video mixer. Mr. Kishore Sadhwani, 20/A, Ram Sarup Khethri Road, Calcutta - 700 053.

WANTED - Books on remote control projects and second books on electronics (For beginners). Software for BBC computer. Mr. Hinder Singh, 523, Ghumar Mandi (Karol Bagh) Ludhiana, Punjab - 141 001.

INTERESTED - in Pen Friendship with electronic hobbyists for exchange of circuits. Mr. R. Kowser, c/o A. Khan, Final B.E. (E & C) Room No. 13A Muslim Hostel, R.H. Road, Tumkur - 572 103.

FOR SALE - A brand new Casio VL-Tone VL-1, a electronic musical instrument and calculator. Mr. R.P. Kolte, 'Suprabha 49, Jyoti Nagar, New Osmapur, Aurangabad - 431 001.

FOR SALE - Completely assembled 103 LED digital clock with alarm, sleep, hourly chime and circuit details. Mr. Ujjal kumar Jain, S/O. Sh. P.S. Jain, A/13, Nehru Ground, N.I.T. Faridabad, Haryana - 121 001.

WANTED - Back issues of QST, amateur radio magazine of ARRL, reasonable price offered. Mr. Raghendra Bhat, Maruthi Vilas, Cannon shed Road, Cochín Kerala - 682 855.

INTERESTED - In Pen Friendship with electronics hobbyists for exchange of simple circuits and ideas. Mr. Kuljit Singh, 23-Mahendra Kuni Society, Khokhra Mehmedabad, Ahmedabad - 380 008.

WANTED - YASEU. Kenwood or ICOM HF transceiver in good working condition immediately. Also a Sinclair ZX81 computer. Mr. P.Ravi Shanker, S/O P. Nityanand, Air Correspondent, 16/901, K.C. Colony, Bellary - 583 101.

WANTED - 6000UF, 60UF, 80UF, 30UF, 12F and 5UF. All above 50V-BI Polar electrolytic, polypropylene, polyester or polycarbonate. Mr. Soo Seng Yin Dragon Garden, Kamper 31900, Parak, Malaysia.

WANTED - Back issue of Elektor Aug/Sept. '88. Mr. Kishore Kumar S/O. P.K. Vaman Ganamajalu House, Shakti Nagar, Post, Mangalore - 575 016.

WANTED - SOLID STATE Oscilloscope circuit with full construction details. Mr. S.M. Vishwakarma, Second Floor, 45, Suburban School Road, Calcutta - 700 025.

FOR SALE - Lab Grade 3 1/2 digit benchtop digital multimeter with auto ranging, memory, data hold, bargraph display and HFE testing. CONTACT Kavi Avari, G-C Banoo Mansions, Cumballa Hill, Bombay-400 036.

SALE - Dual element 345mm Fresnel's Lens for projection TV can be used with any TV with screen size 80" diagonal. Mr. Santanu Kumar Bhattacharya, Plot - 1591, Sector - 15, Faridabad - 121 002.

FOR SALE - ZX spectrum 48K, ZX81, 16K Software. Also programme books & key board for ZX81. Mr. Deepak Gupta, 115/2, Hazra Road, Calcutta - 700 026.

WANTED - Second Hand Books on Ham radio and shortwave listening and circuit diagram of communication radio. Mr. Alex Fernandes, House No.7, near Fragnel Ashram, Verna Matoc, Salcete, Goa - 403 722.

WANTED - Analog Voltmeter supplier for a personal project, range 300 V, AMP'S. WANT URGENTLY. Mr. M.A. Kambalyal, C/O C.I. Kalyana Shetra, Pagadi Oni Hubli - 20 Karnataka.

FOR SALE - ZX Spectrum +, With power supply and manual. V. Unamateshwara Rao, D-No. 40-15/1-16, Brindavan Colony, Vijayawada 520 010.

INTERESTED: Contact with Engineers in Calcutta for exchange of Electronic circuits ideas, Microprocessor software. D. Ghosh, BB 266, Sector 1, Salt Lake, Calcutta 700 064, Phone 370 089.

FREE advertising for our readers!

Rules:

- Private advertisers only. No trade, no business.
 - Full address or private telephone number; no post office boxes.
 - Items related to electronics only. Software only when related to Elektor computer systems.
 - Maximum length: 114 characters - letter, numeral, comma, space, etc. (not including address and/or telephone number).
 - One advertisement per reader per month.
- To enforce this rule, a switchboard voucher will be printed each month.
- Elektor cannot accept responsibility for any correspondence or transaction as a result of a 'switchboard' ad, nor as a result of any inaccuracy in the text.
 - Ads will be placed in the order in which they are received.
 - We reserve the right to refuse advertisements, without returning them.

I am a private reader. I have read your rules and I enclose a valid switchboard voucher. Please place the following advertisement, free, in the next available space.

BLOCK CAPITALS PLEASE - ONE CHARACTER TO EACH BOX

Name and address:

All advertisements must include the voucher printed here. They must be post-marked within the month indicated.

Send to:

ELEKTOR ELECTRONICS PVT LTD.
Chotani Building 52 C, Proctor Road Grant Road (E)
Bombay 400 007

**elektor
Switchboard**
MARCH '87

"Pcb Pattern, Circuit Diagram Oscillator coil of Stereo tape deck with DBX Noise reduction, variable bias, electronic switching, Vu meters, Phones, Normal Ferrichrome, Chrome, Meta, Sn ratio 100 db, 20 Hz to 20 Khz, Front loading mechanism and cabinet available. Write — Erictronic, C/o Eric Farnandes, Rose Blossom Building, C-26, Sitla Devi, Mahim, Bombay-400016.

KITS - MW Transmitter 500 meters Rs.150.00, Remote control relay 500 meters Rs.125.00. Send 50% advance by M.O.. Ask for kits list to SUPER ELECTRONICS, Shivaji Nagar, Barsi-413411

CORRECTIONS

Analogue wattmeter January 1987 p. 39

The polarity of the 50 μ A meter shown in Fig. 3 must be reversed. In the transistor test circuits shown in Fig. 5, the emitters of T₁ and T₂ must be connected to the + rail, not the collectors as shown.

Computerscope — 2 February 1987 p. 51

In Fig. 10, pins 1,3,5, ... 13 of the printer connector must be grounded. In Fig. 13, signal Φ is omitted; this is present at pin 14. Please add to the parts list: C₅₁=10 μ ; 16 V.

Universal control for stepper motors

February 1987 p. 31

In the first column on page 37 the text "... in the R₂ or R₃ positions" should read "... in the R₁ or R₃ positions". In Table 4, the column stating the jumper must be modified to read (top to bottom) a b a. Please note: IC₆=74HCT139.

It glows and glows
as the darkness grows.

CAT-EYE

A Solid State
Magic Night Lamp



CAT-EYE is a Unique Export Quality Night Lamp which glows only in the dark even if you switch it on in the daylight. It saves energy and is ideal for Safety and Security, operating on 230 V A.C.

Useful for : * Bed rooms * Dark rooms * Processing Labs.

Can be modified for the Special Purpose.
Price Rs. 60/- + Postage Rs. 10/-
Also available in kit form for the hobbyists for Rs. 45/- + Postage Rs. 10/-

NOTE : Send M.O. in advance. No D/D or cheques, Please!

Mfg. By: **TEJUTRON**
97, Masjid Bunder Road, Gaya Bldg., Bombay-400 003.

STOCKIST WANTED

Disposal of stock!

TTL, CMOS, LINEAR
7400-series, 4000 series, LM series,
MUSICAL CHIPS
UM 66, UM 3166,
UM 3481/82/83/84.

VOLTAGE REGULATORS LINEAR
78, 79 series, LM series
RADIO TV & MISCELLANEOUS SERIES
2N 414, 2N 415, 2N 416, AY-3-8500
76477, MM 5387-
DISPLAY DRIVERS COUNTER CHIPS
UM-66 KIT Rs. 20/-

SPECIAL RATES FOR VOLUME ORDERS

ABC ELECTRONICS	3.07
ACE COMPONENTS	3.62
ADVANCE INDUSTRIES	3.12
ADVANCE VIDEO LAB	3.12
AL AMEEN	3.14
ANANT ENTERPRISES	3.04
APEX ELECTRONICS	3.62
CHAMPION	3.61
COMPONENT TECHNIQUE	3.10
CONTROL DEVICE	3.05
CYCLO	3.10
DYNALOG MICRO SYSTEM	3.15
ECONOMY ENGINEERING	3.69
ELCOT	3.57
ELECTRONICA	3.04
ELTEK BOOK IN KITS	2.10
ENGINEERING SYSTEM	3.08
HIGHTECH ELECTRONICS CORPN	3.06
ION ELECTRICALS	3.06
KLAS	3.66
LEADER ELECTRONICS	3.14
LUXCO ELECTRONICS	3.13
MECO INSTRUMENTS	3.65
MOTWANE	3.11
MURUGAPPA	3.59
NAVIN FLUORINE IND	3.76
NCS ELECTRONICS	3.65
PHILIPS	3.09
PIONEER	3.69
PLA	3.73
PRECIOUS ELECTRONICS	3.71
SAINI ELECTRONICS	3.14
SCIENTIFIC	3.12
SMJ ELECTRONICS	3.02
TESTICA	3.62
TEXONIC	3.65
THERMAX	3.08
TRIMURTI ELECTRONICS	3.69
UNLIMITED ELECTRONICS	3.66
VASAVI ELECTRONICS	3.08
VIKAS HYBRIDS	3.04
VISHA ELECTRONICS	3.75



THE SUPPLIER
THAT
ALWAYS
COMES
THROUGH

VISHA
ELECTRONICS

17, Kalpana Building
First Floor
349, Lamington Road
Bombay - 400 007
Tele. 362650.

*We supply all kinds of
Electronic components
including ICs,
Transistors Rectifiers,
Triacs, SCRs, Diacs,
Capacitors, Tantalum
Capacitors, Computer system
components, Head-sinks,
Drafting aids etc.*

*We also deal in PCB
making, and variety of
Electronic Projects. As a kit
we supply the PCB & the
components which goes on
the PCB we also supply
cases, transformers
speakers, etc.*

(ASK FOR A FREE DETAILED PROJECTS BOOKLET)

Now
available
ex-stock to actual
users from Export House

FLUOROCARBON₁₁₃

(Trichlorotrifluoroethane)
and its Methanol Azeotrope

the ideal cleaning solvent used worldwide by the
Electronic Industry

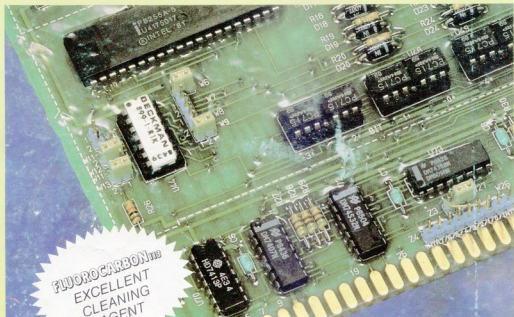

Precision Parts



General Metal Parts



Plastic Parts

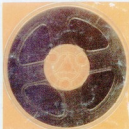

Dry Cleaning



Actual users please contact:

NF Navin Fluorine Industries

Chemical Division of THE MAFATLAL FINE SPG. & MFG. CO. LTD.

Mafatlal Centre, Nariman Point, Bombay 400 021. Tel: 2024547 Grams: MAFINISED Telex: 011-4241 MGMC IN

FERRERA /SSOC/NFI/241/86